

# SOM 10

**STIEBEL ELTRON**

**Simply the Best**

Manual for the  
specialized craftsman

**Mounting**

**Electrical connection**

**Operation**

**Troubleshooting**

**Application examples**



49014260

Thank you for buying this product.  
Read this manual carefully to get the best performance from this unit.  
Please keep this manual carefully.

en-US/CA

Manual

## Safety advice

Please pay attention to the following safety advice in order to avoid danger and damage to people and property.

## Instructions

Attention must be paid to the valid local standards, regulations and directives!

## Information about the product

### Proper usage

The solar controller is designed for use in solar thermal systems and heating systems in compliance with the technical data specified in this manual.

Improper use excludes all liability claims.



### Note

Strong electromagnetic fields can impair the function of the controller.

- Make sure the controller as well as the system are not exposed to strong electromagnetic fields.

**Subject to technical change. Errors excepted.**

## Target group

These instructions are exclusively addressed to authorised skilled personnel.

Only qualified electricians should carry out electrical works.

Initial installation must be effected by qualified personnel named by the manufacturer.

## Description of symbols

### WARNING!



Warnings are indicated with a warning triangle!

→ **They contain information on how to avoid the danger described.**

Signal words describe the danger that may occur, when it is not avoided.

- **WARNING** means that injury, possibly life-threatening injury, can occur.
- **ATTENTION** means that damage to the appliance can occur.



### Note

Notes are indicated with an information symbol.

- Arrows indicate instruction steps that should be carried out.

## Disposal

- Dispose of the packaging in an environmentally sound manner.
- Dispose of old appliances in an environmentally sound manner. Upon request we will take back your old appliances bought from us and guarantee an environmentally sound disposal of the devices.

## Contents

<b>1 Overview</b> .....	<b>4</b>	8.2 Solar optional functions .....	34
1.1 Optional functions.....	5	8.3 Solar expert menu .....	47
<b>2 Installation</b> .....	<b>5</b>	<b>9 Arrangement</b> .....	<b>47</b>
2.1 Mounting .....	5	9.1 Optional functions.....	47
2.2 Electrical connection .....	6	<b>10 Heating</b> .....	<b>59</b>
2.3 Data communication / Bus .....	7	10.1 Demands .....	60
2.4 SD card slot.....	8	10.2 Heating circuits .....	60
<b>3 Step-by-step parameterization</b> .....	<b>8</b>	10.3 Optional functions.....	64
<b>4 Operation and function</b> .....	<b>9</b>	<b>11 HQM</b> .....	<b>67</b>
4.1 Buttons .....	9	<b>12 Basic settings</b> .....	<b>69</b>
4.2 Selecting menu points and adjusting values .....	9	<b>13 SD card</b> .....	<b>69</b>
4.3 Menu structure .....	11	<b>14 Manual mode</b> .....	<b>71</b>
<b>5 Initial commissioning</b> .....	<b>12</b>	<b>15 User code</b> .....	<b>72</b>
5.1 Basic systems and hydronic variants .....	14	<b>16 In- / Outputs</b> .....	<b>72</b>
5.2 Overview of relay and sensor allocation .....	15	16.1 Modules .....	72
<b>6 Main menu</b> .....	<b>30</b>	16.2 Inputs.....	73
<b>7 Status</b> .....	<b>30</b>	16.3 Outputs .....	74
7.1 Solar.....	30	16.4 PWM-Profiles .....	75
7.2 Arrangement .....	30	<b>17 Troubleshooting</b> .....	<b>76</b>
7.3 Heating.....	30	<b>18 Accessories</b> .....	<b>80</b>
7.4 Messages.....	30	18.1 Sensors and measuring instruments.....	80
7.5 Meas. / Balance values.....	31	18.2 VBus® accessories .....	81
7.6 Service .....	31	18.3 Interface adapters.....	81
<b>8 Solar</b> .....	<b>31</b>	<b>19 Index</b> .....	<b>82</b>
8.1 Basic solar settings .....	31		

## 1 Overview

- Extra large graphic display
- 14 relay outputs
- 12 temperature sensors (system-dependent)
- 4 inputs for Grundfos Direct Sensors™ (2 × analog, 2 × digital)
- 4 PWM outputs for speed control of high-efficiency pumps
- Datalogging / firmware updates via SD memory card
- 2 internal, weather-compensated heating circuits
- Pre-programmed optional functions
- Drainback option
- Time-controlled thermostat function
- Heating period thermal disinfection
- VBus®
- Energy-saving switch-mode power supply

### Included:

- 1 x SOM 10
- 1 x accessory bag
  - 3 x screw and wall plug
  - 13 x strain relief and screw

Additionally enclosed in the full kit:

- 2 x FKP6 temperature sensor
- 4 x FRP6 temperature sensor



### Note

The SD card is not included with the controller. For more information about accessories, see page 69

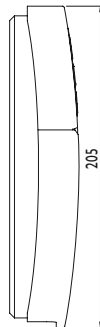
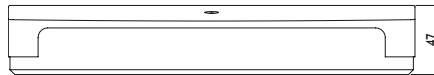
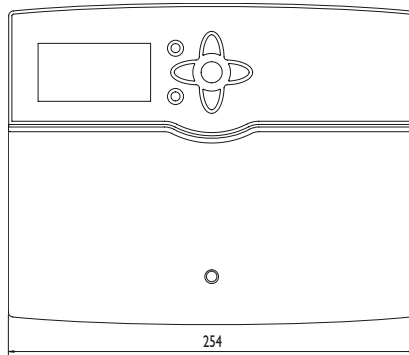

### Technical data

**Housing:** plastic, PC-ABS and PMMA

**Protection type:** IP 20 / EN 60529

**Protection class:** I

**Ambient temp.:** 0...40 °C [32...104 °F]

**Dimensions:** 254 × 205 × 47 mm [10" × 8.1" × 1.9"]

**Mounting:** wall mounting, also suitable for mounting into patch panels

**Display:** Full graphic display, control lamp (directional pad) and background illumination

**Operation:** 7 push buttons at the front of the housing

**Functions:** System controller for solar and heating systems. Functions such as:  $\Delta T$  control, pump speed control, energy metering, operating hours counter for the solar pump, evacuated tube collector function, thermostat function, vertical tank loading, priority logic, drainback option, booster function, heat dump function, thermal disinfection function, PWM pump control, function control according to BAFA guidelines.

**Inputs:** 12 Pt1000, Pt500 or KTY temperature sensor inputs (7 of them can optionally be used for RTA11-M remote controls), 3 inputs for V40 flowmeters, inputs for 2 digital and 2 analog Grundfos Direct Sensors™, 1 input for a CS10 irradiation sensor

**Outputs:** 13 semiconductor relays, 1 dry contact relay, 4 PWM outputs

**Interfaces:** VBus®, SD card slot

**Power supply:** 100 ... 240V~, 50 ... 60 Hz

**Switching capacities per relay:**

1 (1) A 100 ... 240 V~ (semiconductor relay)

4 (2) A 100 ... 240 V~ (dry contact relay)

**Total switching capacity:** 6.3 A

**Standby power consumption:** < 1W

**Mode of operation:** type 1.Y

**Degree of pollution:** 2

**Rated impulse voltage:** 2.5 kV

**Contact termination:** Y

## 1.1 Optional functions

### Solar

Bypass  
CS Bypass  
External heat exchanger  
Evacuated tube collector  
Target temperature  
Antifreeze  
Backup heating suppression  
Parallel relay  
Cooling mode  
Drainback  
Twin pump  
Heat dump  
Flow rate monitoring

### Arrangement

Parallel relay  
Mixer  
Boiler loading  
Error relay  
Heat exchange  
Solid fuel boiler  
Circulation  
Return preheating  
Function block  
Irradiation switch

### Heating

Thermal Disinfection  
DHW heating

## 2 Installation

### 2.1 Mounting

The unit must only be located in dry interior rooms. The controller must additionally be supplied from a double pole switch with contact gap of at least 3 mm [0.12"].

Please pay attention to separate routing of sensor cables and power supply cables.

In order to mount the device to the wall, carry out the following steps:

- Unscrew the cross-head screw from the cover and remove it along with the cover from the housing
- Mark the upper fastening point on the wall. Drill and fasten the enclosed wall plug and screw leaving the head protruding
- Hang the housing from the upper fastening point and mark the lower fastening points (centres 223 mm [8.8"])
- Insert lower wall plugs
- Fasten the housing to the wall with the lower fastening screws and tighten
- Carry out the electrical wiring in accordance with the terminal allocation, see chap. 2.2
- Put the cover on the housing
- Attach with the fastening screw



#### Note

Strong electromagnetic fields can impair the function of the controller.

Make sure the controller as well as the system are not exposed to strong electromagnetic fields.

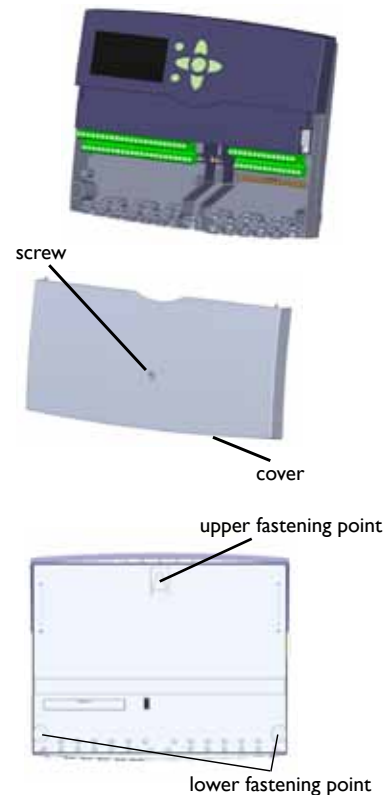

#### WARNING!



#### Electric shock!

Upon opening the housing, live parts are exposed.

- **Always disconnect the controller from power supply before opening the housing!**

## 2.2 Electrical connection



### Note

Connecting the device to the power supply must always be the last step of the installation!

The controller is equipped with 14 **relays** in total to which loads such as pumps, valves, etc. can be connected:

Relays 1 ... 13 are semiconductor relays, designed for pump speed control:

Conductor R1 ... R13

Neutral conductor N (common terminal block)

Protective grounding conductor  $\perp$  (common terminal block)

Relay 14 is a dry contact relay:

R14-A = normally open contact

R14-M = center contact

R14-R = normally closed contact

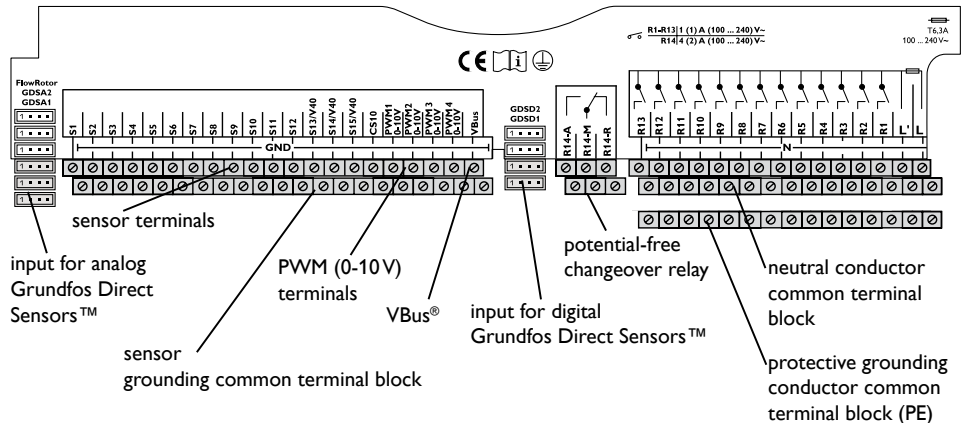
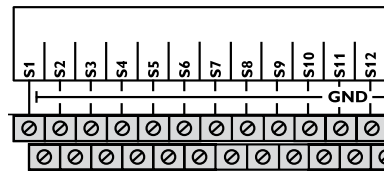

### WARNING!

### ESD damage!

Electrostatic discharge can lead to damage to electronic components!

→ **Take care to discharge properly before touching the inside of the device! To do so, touch a grounded surface such as a radiator or tap!**



### Note:

The pump speed must be set to 100 % when auxiliary relays or valves are connected.

### WARNING!

### Electric shock!



Upon opening the housing, live parts are exposed.

→ **Always disconnect the controller from power supply before opening the housing!**



### Note

For more details about the initial commissioning procedure, see page 12.

Depending on the product version, power supply cables and sensor cables are already connected to the device. If that is not the case, please proceed as follows:

**Temperature sensors** have to be connected to the terminals S1 ... S12 and GND (either polarity).

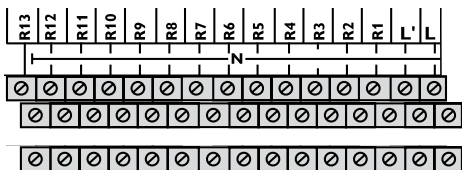
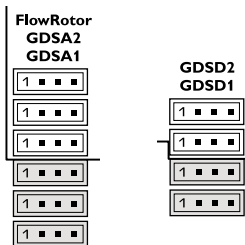
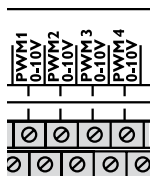
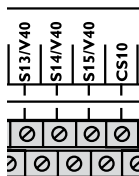

The terminals S13 to S15 can be used as either impulse inputs for V40 flowmeters or as inputs for F508 flow switches

V40 flowmeters can be connected to the terminals S13 / V40 to S15 / V40 and GND (either polarity).

Connect the irradiation sensor **CS10** to the terminals CS10 and GND with correct polarity. To do so, connect the cable marked GND to the GND common terminal block, the cable marked CS to the terminal marked CS10.

**The terminals marked PWM** are control outputs for high-efficiency pumps.

In the In-/Outputs menu, relays can be allocated to the PWM outputs.

Connect the **FlowRotor** to the input marked FlowRotor.

Connect the **analog Grundfos Direct Sensors™** to the inputs GDSA1 and GDSA2.

Connect the **digital Grundfos Direct Sensors™** to the GDSD1 and GDSD2 inputs.

The controller is supplied with power via a power supply cable. The power supply of the device must be 100 ... 240 V~ (50 ... 60Hz).

The **power supply connection** is at the terminals:

Neutral conductor N

Conductor L

Conductor L' (L' is not connected with the power supply cable. L' is a fused contact permanently carrying voltage)

Protective grounding conductor ⊕ (common terminal block)

### 2.3 Data communication / Bus

The controller is equipped with the **VBus®** for data transfer with and energy supply to external modules. The connection is carried out at the two terminals marked VBus and GND (any polarity). One or more VBus® modules can be connected via this data bus, such as:

- GA3 Large Display module / Smart Display SD3
- AM1 Alarm module
- DL2 Datalogger
- EM Extension module

Furthermore, the controller can be connected to a PC via the VBus®/USB or VBus®/LAN interface adapter (not included with the SOM 10). With the **ServiceCenter Software (RSC)**, measured values can be read, processed and visualized. The software allows easier parametrisation and function control of the system.



#### Note:

For more information about accessories, see page 80

#### WARNING!

#### Electric shock!



L' is a fused contact permanently carrying voltage

→ **Always disconnect the controller from power supply before opening the housing!**

## 2.4 SD card slot

The controller is equipped with an SD card slot.

With an SD card, the following functions can be carried out:

- Store measurement and balance values onto the SD card. After the transfer to a computer, the values can be opened and visualized, e. g. in a spreadsheet programme.
- Prepare adjustments and parameterizations on a computer and transfer them via the SD card.
- Store adjustments and parameterizations on the SD card and, if necessary, retrieve them from there.
- Download firmware updates from the Internet and install them on the controller.

A standard SD card is not included with the SOM 10.

For more information about using an SD card, see page 69.



## 3 Step-by-step parameterization

The SOM 10 is a controller that offers a broad variety of functions to the user. At the same time, the user has a lot of freedom in configuring them. Therefore, to set up a complex system, careful planning is required. We recommend drawing a sketch of the system first. If planning, hydronic execution and electrical connection have all been carried out successfully, proceed as follows:

### 1. Running the commissioning menu

The commissioning menu is run after the first connection and after every reset. It will request the following basic adjustments:

- Menu language
- Temperature unit
- Volume unit
- Pressure unit
- Energy unit
- Time
- Date
- Solar system
- Hydronic variant

At the end of the commissioning menu, a safety enquiry follows. If the safety enquiry is confirmed, the adjustments are saved.

For further information about the commissioning menu see page 12.

### 2. Registering sensors

If flowmeters, flow switches, Grundfos Direct Sensors™ and/or external extension modules are connected, these have to be registered in the In-/Outputs menu.

For further information about the registration of modules and sensors see page 72.

### 3. Activating solar optional functions

The basic solar system has been adjusted during commissioning. Now, optional functions can be selected, activated and adjusted.

Free relays can be allocated to optional functions which require a relay. The controller always suggests the numerically smallest free relay.

Sensors can be allocated to more than one function.

For further information about the solar optional functions see page 34.

### 4. Activating optional arrangement functions

Now, optional functions for the non-solar part of the arrangement can be selected, activated and adjusted.

Free relays can be allocated to optional functions which require a relay. The controller always suggests the numerically smallest free relay.

Sensors can be allocated any number of times without impairing any other functions.

For further information about the optional arrangement functions see page 47.

### 5. Adjusting heating circuits and activating optional heating functions

Now, heating circuits can be activated and adjusted. Internal heating circuits are only offered as long as at least 3 relays are free.

For the heating part of the arrangement, optional functions can be selected, activated and adjusted.

To heating circuits and optional functions which require one or more relays, the corresponding number of free relays can be allocated. The controller always suggests the numerically smallest free relay.

Sensors can be allocated any number of times without impairing any other functions.

For further information about heating circuits and optional heating functions see page 59.



## 4 Operation and function

### 4.1 Buttons

The controller is energized via the 7 buttons next to the display. They have the following functions:

Button - scrolling upwards

Button - scrolling downwards

Button - increasing adjustment values

Button - reducing adjustment values

Button - confirming

Button - entering the status menu / chimney sweeper mode (system-dependent)

Button - escape button for changing into the previous menu

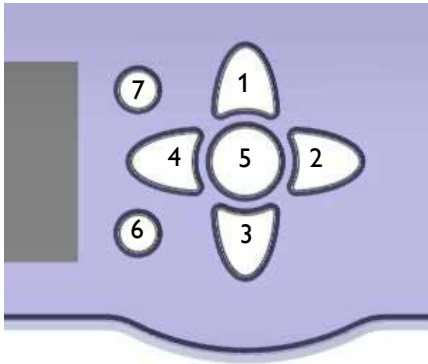

### 4.2 Selecting menu points and adjusting values

During normal operation of the controller, the display is in the main menu. If no button is pressed for a few seconds, the display illumination goes out.

Press any key to reactivate the display illumination.

→ In order to scroll through a menu or to adjust a value, press either buttons and or buttons

and

→ To open a submenu or to confirm a value, press button

→ To enter the status menu, press button – unconfirmed adjustments will not be saved

→ To switch one menu level upwards press button – unconfirmed adjustments will not be saved

If no button has been pressed within a couple of minutes, the adjustment is cancelled and the previous value is retained.

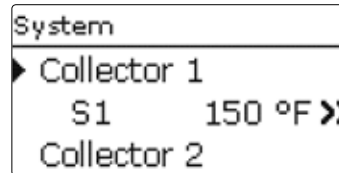

If the symbol is shown behind a menu item, pressing button will open a new submenu.

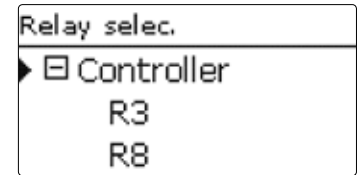

If the symbol is shown in front of a menu item, pressing button will open a new submenu. If it is already opened, a is shown instead of the .

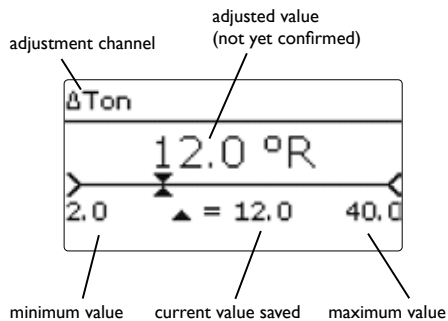

Values and adjustments can be changed in different ways:

Numeric values can be adjusted by means of a slide bar. The minimum value is indicated to the left, the maximum value to the right. The large number above the slide bar indicates the current adjustment. By pressing buttons  $\leftarrow$  or  $\rightarrow$  the upper slide bar can be moved to the left or to the right.

Only after the adjustment has been confirmed by pressing button  $\odot$  will the number below the slide bar indicate the new value. The new value will be saved if it is confirmed by pressing button  $\odot$  again.

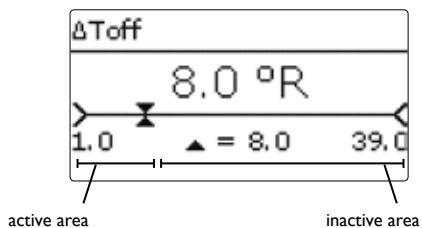

When two values are locked against each other, they will display a reduced adjustment range depending on the adjustment of the respective other value.

In this case, the active area of the slide bar is shortened, the inactive area is indicated as a dotted line. The indication of the minimum and maximum values will adapt to the reduction.

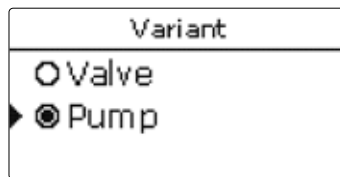

If only one item of several can be selected, they will be indicated with "radio buttons". When one item has been selected, the radio button in front of it is filled.

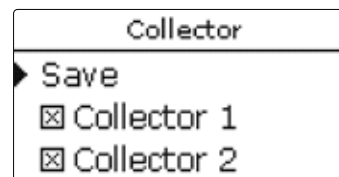

If more than one item of several can be selected, they will be indicated with checkboxes. When an item has been selected, an x appears inside the checkbox.

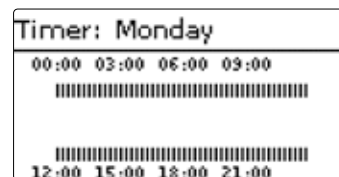

The time frames for the timer can be adjusted in steps of 15 minutes on a time line.

The cursor can be moved along the time line by pressing buttons  $\leftarrow$  or  $\rightarrow$ . The beginning of a time frame can be determined by pressing button  $\uparrow$ .

The end of a time frame can be determined by pressing button  $\downarrow$ .

### 4.3 Menu structure

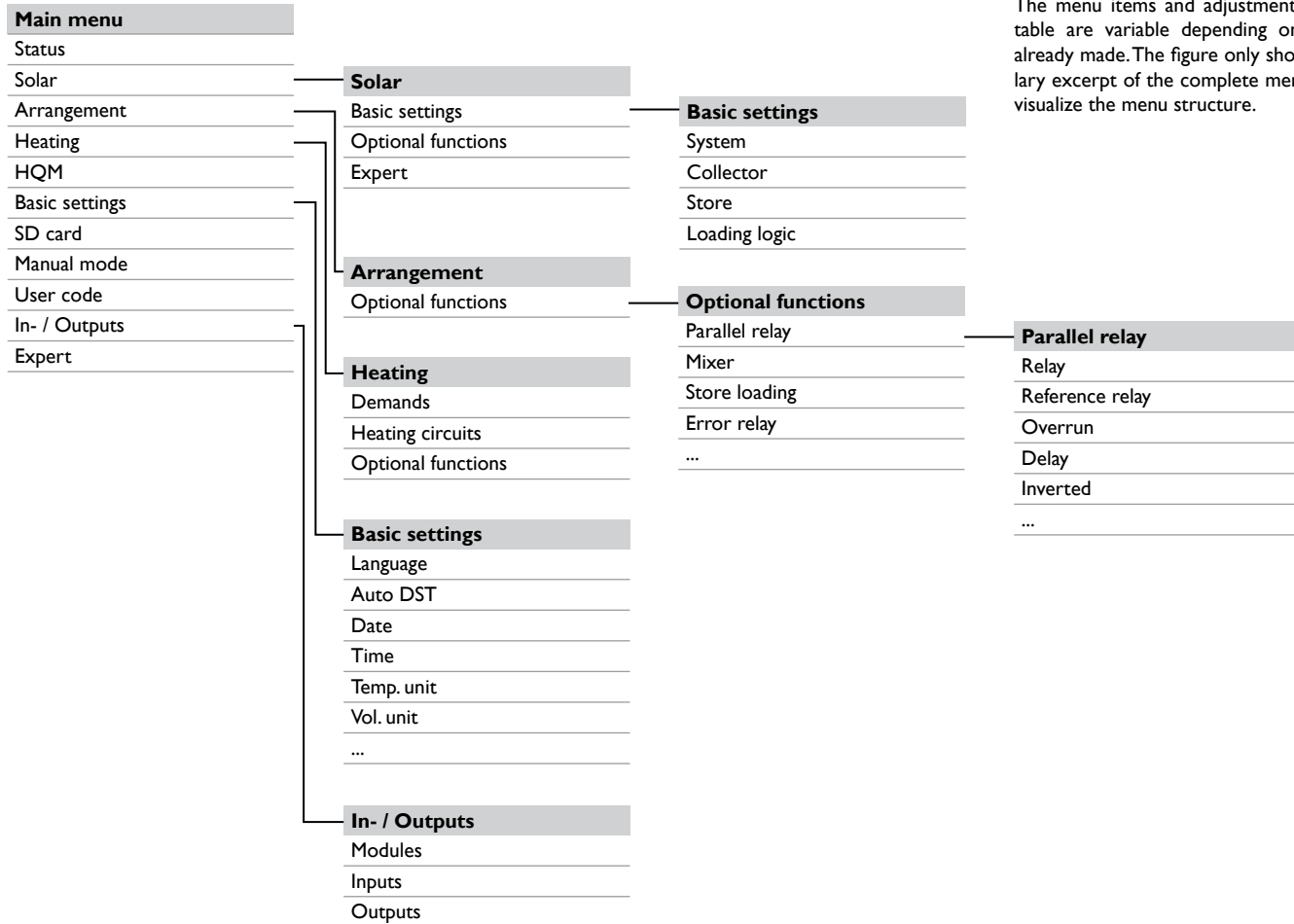

The menu items and adjustment values selectable are variable depending on adjustments already made. The figure only shows an exemplary excerpt of the complete menu in order to visualize the menu structure.

## 5 Initial commissioning

When the hydronic system is filled and ready for operation, connect the controller to the power supply.

The controller runs an initialization phase in which the directional pad flashes red.

When the controller is commissioned for the first time or when it is reset, it will run a commissioning menu after the initialization phase. The commissioning menu leads the user through the most important adjustment channels needed for operating the system.

### Commissioning menu

The commissioning menu consists of the channels described in the following. In order to make an adjustment, push button **5**. Adjust the value by pressing buttons **4** and **2**, then push button **5** to confirm. The next channel will appear on the display.

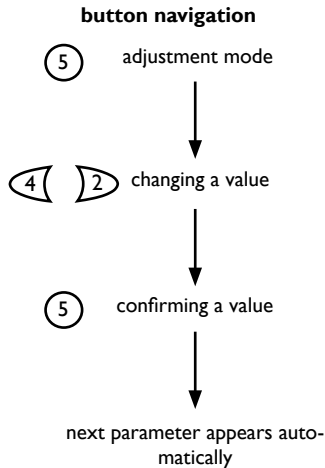

### 1. Language:

→ Adjust the desired menu language.

Language
Deutsch
▶ English
Francais

### 2. Units:

→ Adjust the desired temperature unit.

Temp. Unit
▶ <input checked="" type="radio"/> °F
<input type="radio"/> °C

→ Adjust the desired volume unit.

Flow Unit
<input type="radio"/> Gallons
▶ <input checked="" type="radio"/> Litre

→ Adjust the desired pressure unit.

Press. Unit
<input type="radio"/> psi
▶ <input checked="" type="radio"/> bar

→ Adjust the desired energy unit.

Energy Unit
<input type="radio"/> BTU
▶ <input checked="" type="radio"/> Wh

### 3. Daylight savings time adjustment:

- Activate or deactivate the automatic daylight savings time adjustment.

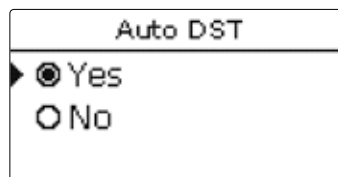

### 4. Time:

- Adjust the clock time. First of all adjust the hours, then the minutes.

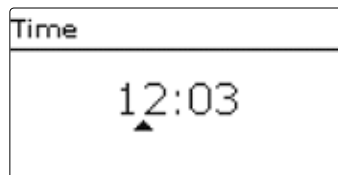

### 5. Date:

- Adjust the date. First of all adjust the year, then the month and then the day.

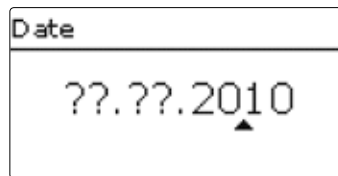

### 6. Selection of the solar system:

- Adjust the desired solar system (number of collectors and stores, hydronic variants).

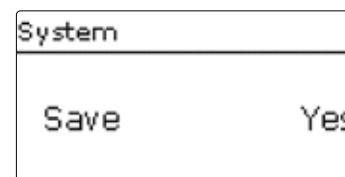
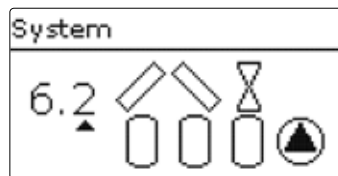

### 7. Completing the commissioning menu:

After the system has been selected, a security enquiry appears. If the enquiry is confirmed, the adjustments will be saved.

- In order to confirm the security enquiry, press button **5**.
- In order to reenter the commissioning menu channels, press button **7**.

If the security enquiry has been confirmed, the controller is ready for operation and should enable an optimum system operation.

All adjustments made during commissioning can, if necessary, be changed later on in the **basic settings** menu.

## 5.1 Basic systems and hydronic variants

### System

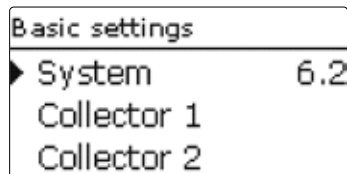

The controller is preprogrammed for 9 basic systems. The selection depends on the number of heat sources (collector fields) and heat sinks (stores, pool). Factory setting is system 1.

The selection of the basic solar system is one of the most important adjustments and is thus requested already in the commissioning menu.

First, the basic system is adjusted by means of the number of stores and collectors fields, then the hydronic variant.

The selected system is visualized by the corresponding number of store and collector symbols. The figure to the left shows system 6 which consists of 3 stores and 2 collector fields ("east- / west collectors").

System 0: no solar system	
System 1: 1 collector field	- 1 store
System 2: east- / west collectors	- 1 store
System 3: 1 collector field	- 2 stores
System 4: east- / west collectors	- 2 stores
System 5: 1 collector field	- 3 stores
System 6: east- / west collectors	- 3 stores
System 7: 1 collector field	- 4 stores
System 8: east- / west collectors	- 4 stores
System 9: 1 collector field	- 5 stores

A solar system with vertical tank loading is implemented as a 2-store system (store top = store 1; store bottom = store 2).

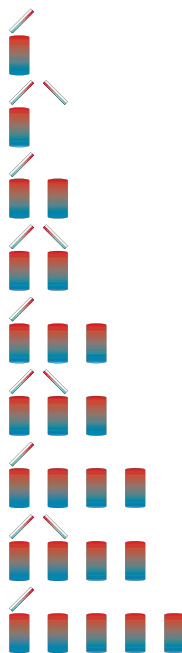

### Variant

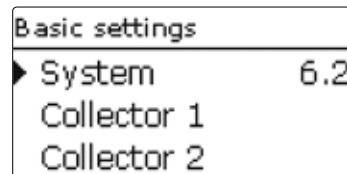

The hydronic variant refers to the different actuators that are to be controlled. They are visualized on the display by means of symbols, when the variant is selected. The upper symbol indicates the actuator belonging to the collector fields, the lower one the actuators belonging to the stores.

The exemplary figure shows the display indicated when system 6, variant 2 has been selected. In this case, each collector field has a 2-port valve, the stores are loaded by means of pump logic.

For each variant, the controller allocates the corresponding relays and sensors. The allocations of the most important combinations are shown in 5.2.

## 5.2 Overview of relay and sensor allocation

### System 1

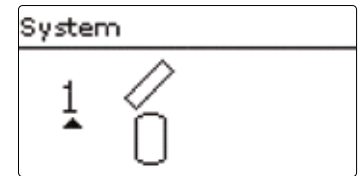
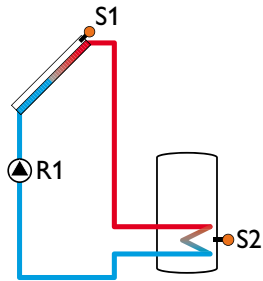

### Relay / sensor allocation

	1	2	3	4	5	6	7	8	9	10-14
Relay	Solar pump	Opt. function	Opt. function	Opt. function	Opt. function	Opt. function	Opt. function	Opt. function	Opt. function	Opt. function
Sensor	Collector 1	Tank bottom	Free	Free	Free	Free	Free	Free	Free	Free

### System 2 variant 1

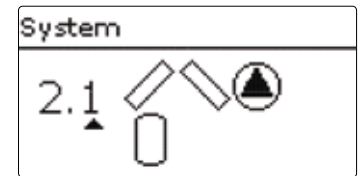
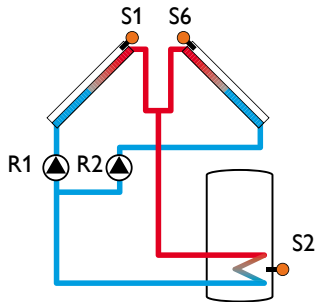

### Relay / sensor allocation

	1	2	3	4	5	6	7	8	9	10-14
Relay	Pump coll. 1	Pump coll. 2	Opt. function	Opt. function	Opt. function	Opt. function	Opt. function	Opt. function	Opt. function	Opt. function
Sensor	Collector 1	Tank bottom	Free	Free	Free	Collector 2	Free	Free	Free	Free

### System 2 variant 2

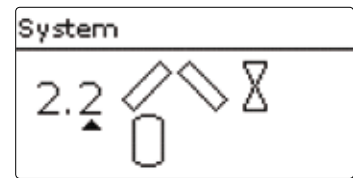
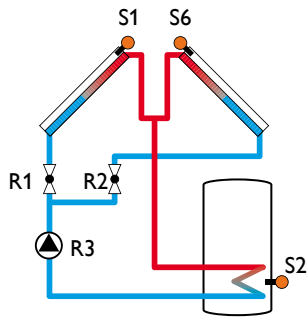

### Relay / sensor allocation

	1	2	3	4	5	6	7	8	9	10-14
Relay	2PV coll. 1	2PV coll. 2	Solar pump	Opt. function	Opt. function	Opt. function	Opt. function	Opt. function	Opt. function	Opt. function
Sensor	Collector 1	Tank bottom	Free	Free	Free	Collector 2	Free	Free	Free	Free

### System 3 variant 1

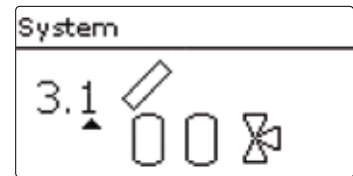
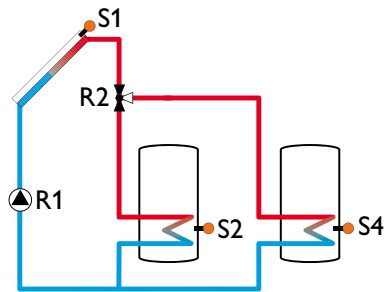

### Relay / sensor allocation

	1	2	3	4	5	6	7	8	9	10-14
Relay	Solar pump	3PV tank 2	Optional function	Optional function	Optional function	Optional function	Optional function	Optional function	Optional function	Optional function
Sensor	Collector	Tank 1 bottom	Free	Tank 2 bottom	Free	Free	Free	Free	Free	Free



### System 3 variant 2

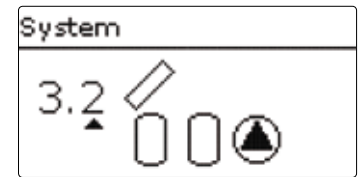
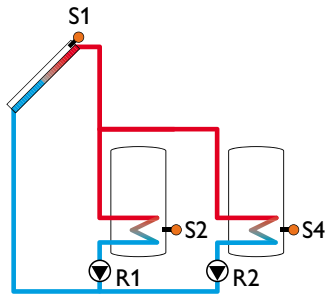

### Relay / sensor allocation

	1	2	3	4	5	6	7	8	9	10-14
Relay	Solar pump tank 1	Solar pump tank 2	Optional function	Optional function	Optional function	Optional function	Optional function	Optional function	Optional function	Optional function
Sensor	Collector	Tank 1 bottom	Free	Tank 2 bottom	Free	Free	Free	Free	Free	Free

### System 3 variant 3

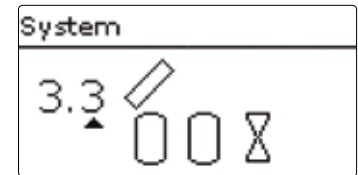
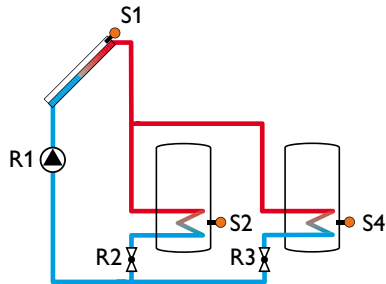

### Relay / sensor allocation

	1	2	3	4	5	6	7	8	9	10-14
Relay	Solar pump	2PV tank 1	2PV tank 2	Optional function	Optional function	Optional function	Optional function	Optional function	Optional function	Optional function
Sensor	Collector	Tank 1 bottom	Free	Tank 2 bottom	Free	Free	Free	Free	Free	Free

### System 4 variant 1

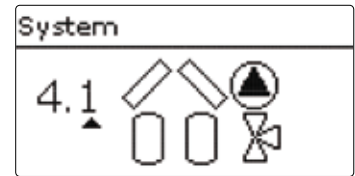
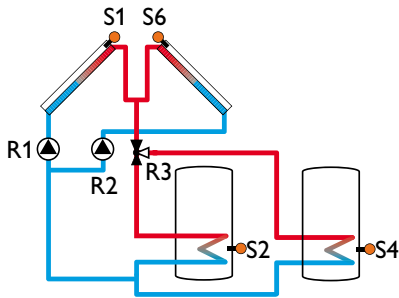

### Relay / sensor allocation

	1	2	3	4	5	6	7	8	9	10-14
Relay	Pump coll. 1	Pump coll. 2	3PV tank 2	Optional function	Optional function	Optional function	Optional function	Optional function	Optional function	Optional function
Sensor	Collector 1	Tank 1 bottom	Free	Tank 2 bottom	Free	Collector 2	Free	Free	Free	Free

### System 4 variant 2

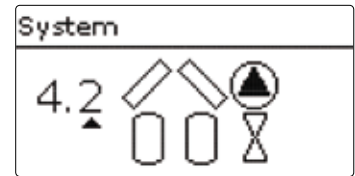
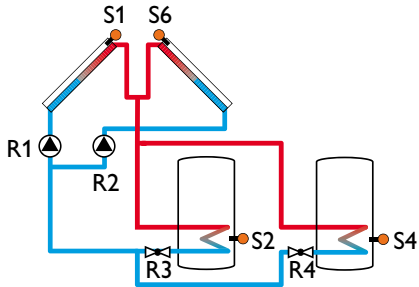

### Relay / sensor allocation

	1	2	3	4	5	6	7	8	9	10-14
Relay	Pump coll. 1	Pump coll. 2	2PV tank 1	2PV tank 2	Optional function	Optional function	Optional function	Optional function	Optional function	Optional function
Sensor	Collector 1	Tank 1 bottom	Free	Tank 2 bottom	Free	Collector 2	Free	Free	Free	Free

### System 4 variant 3

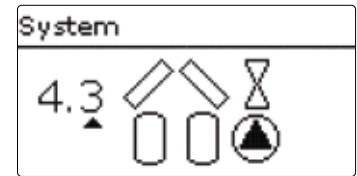
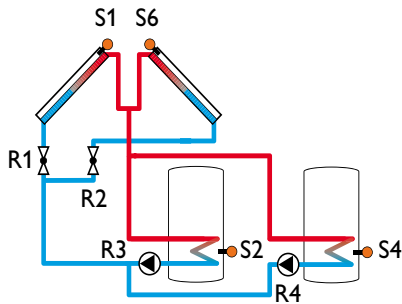

#### Relay / sensor allocation

	1	2	3	4	5	6	7	8	9	10-14
Relay	2PV coll. 1	2PV coll. 2	Solar pump tank 1	Solar pump tank 2	Optional function	Optional function	Optional function	Optional function	Optional function	Optional function
Sensor	Collector 1	Tank 1 bottom	Free	Tank 2 bottom	Free	Collector 2	Free	Free	Free	Free

### System 4 variant 4

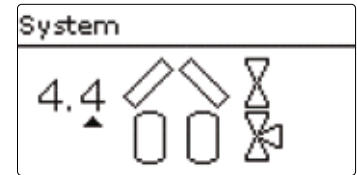
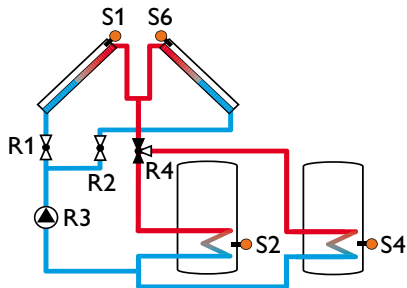

#### Relay / sensor allocation

	1	2	3	4	5	6	7	8	9	10-14
Relay	2PV coll. 1	2PV coll. 2	Solar pump	3PV tank 1	Optional function	Optional function	Optional function	Optional function	Optional function	Optional function
Sensor	Collector 1	Tank 1 bottom	Free	Tank 2 bottom	Free	Collector 2	Free	Free	Free	Free

### System 5 variant 1

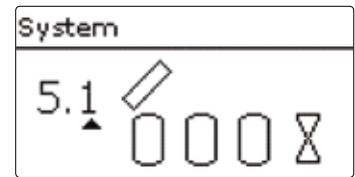
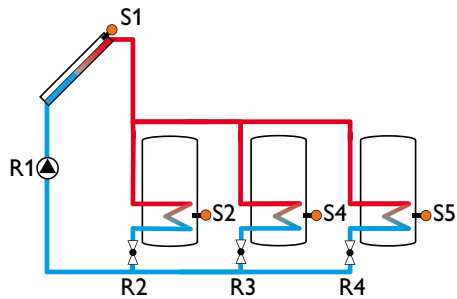

### Relay / sensor allocation

	1	2	3	4	5	6	7	8	9	10-14
Relay	Solar pump	2PV tank 1	2PV tank 2	2PV tank 3	Optional function	Optional function	Optional function	Optional function	Optional function	Optional function
Sensor	Collector 1	Tank 1 bottom	Free	Tank 2 bottom	Tank 3 bottom	Free	Free	Free	Free	Free

### System 5 variant 2

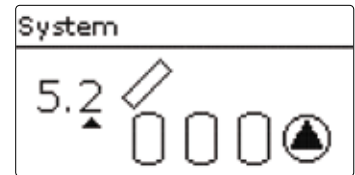
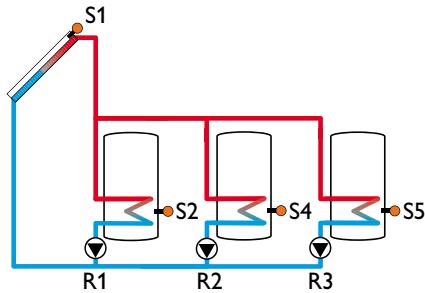

### Relay / sensor allocation

	1	2	3	4	5	6	7	8	9	10-14
Relay	Solar pump tank 1	Solar pump tank 2	Solar pump tank 3	Optional function	Optional function	Optional function	Optional function	Optional function	Optional function	Optional function
Sensor	Collector 1	Tank 1 bottom	Free	Tank 2 bottom	Tank 3 bottom	Free	Free	Free	Free	Free

### System 5 variant 3

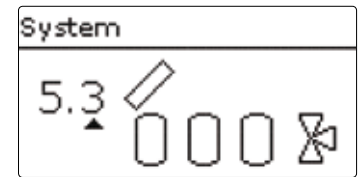
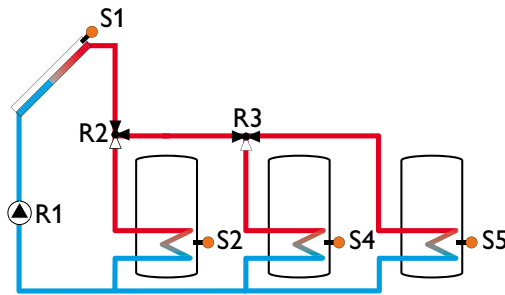

### Relay / sensor allocation

	1	2	3	4	5	6	7	8	9	10-14
Relay	Solar pump	3PV tank 1	3PV tank 2	Optional function	Optional function	Optional function	Optional function	Optional function	Optional function	Optional function
Sensor	Collector 1	Tank 1 bottom	Free	Tank 2 bottom	Tank 3 bottom	Free	Free	Free	Free	Free

### System 6 variant 1

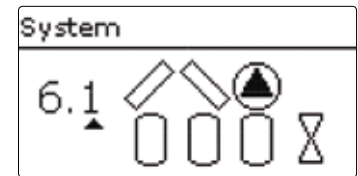
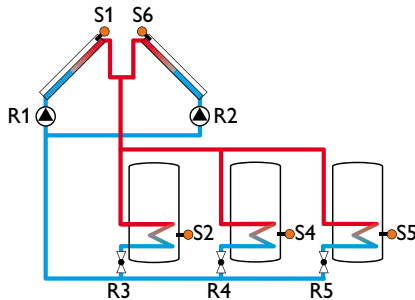

### Relay / sensor allocation

	1	2	3	4	5	6	7	8	9	10-14
Relay	Pump coll. 1	Pump coll. 2	2PV tank 1	2PV tank 2	2PV tank 3	Optional function	Optional function	Optional function	Optional function	Optional function
Sensor	Collector 1	Tank 1 bottom	Free	Tank 2 bottom	Tank 3 bottom	Collector 2	Free	Free	Free	Free

### System 6 variant 2

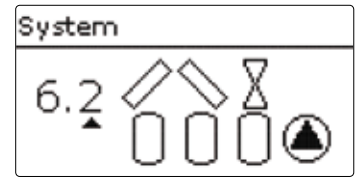
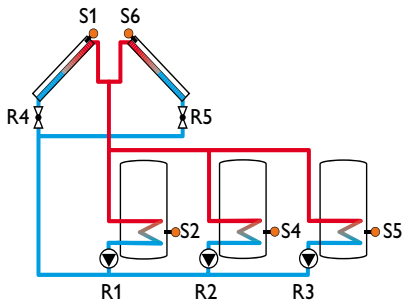

### Relay / sensor allocation

	1	2	3	4	5	6	7	8	9	10-14
Relay	Solar pump tank 1	Solar pump tank 2	Solar pump tank 3	2PV coll. 1	2PV coll. 2	Optional function	Optional function	Optional function	Optional function	Optional function
Sensor	Collector 1	Tank 1 bottom	Free	Tank 2 bottom	Tank 3 bottom	Collector 2	Free	Free	Free	Free

### System 6 variant 3

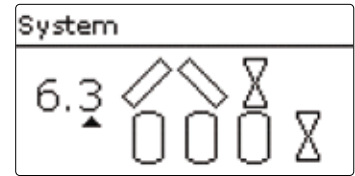
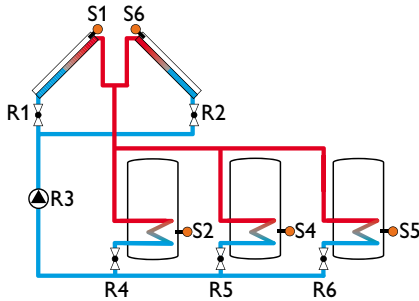

### Relay / sensor allocation

	1	2	3	4	5	6	7	8	9	10-14
Relay	2PV coll. 1	2PV coll. 2	Solar pump	2PV tank 1	2PV tank 2	2PV tank 3	Optional function	Optional function	Optional function	Optional function
Sensor	Collector 1	Tank 1 bottom	Free	Tank 2 bottom	Tank 3 bottom	Collector 2	Free	Free	Free	Free

### System 6 variant 4

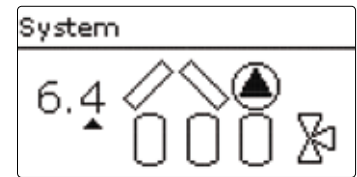
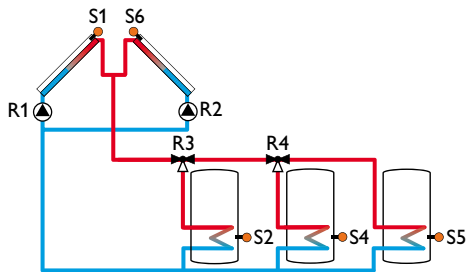

### Relay / sensor allocation

	1	2	3	4	5	6	7	8	9	10-14
Relay	Pump coll. 1	Pump coll. 2	3PV tank 1	3PV tank 2	Optional function	Optional function	Optional function	Optional function	Optional function	Optional function
Sensor	Collector 1	Tank 1 bottom	Free	Tank 2 bottom	Tank 3 bottom	Collector 2	Free	Free	Free	Free

### System 6 variant 5

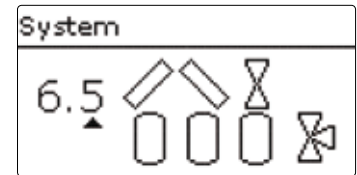
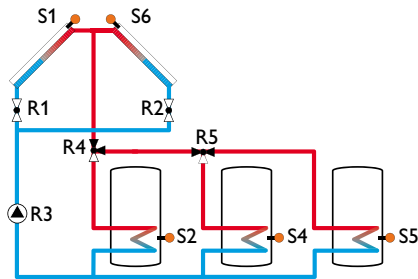

### Relay / sensor allocation

	1	2	3	4	5	6	7	8	9	10-14
Relay	2PV coll. 1	2PV coll. 2	Solar pump	3PV Tank 1	3PV Tank 2	Optional function	Optional function	Optional function	Optional function	Optional function
Sensor	Collector 1	Tank 1 bottom	Free	Tank 2 bottom	Tank 3 bottom	Collector 2	Free	Free	Free	Free

### System 7 variant 1

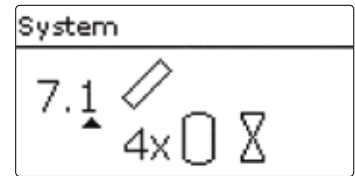
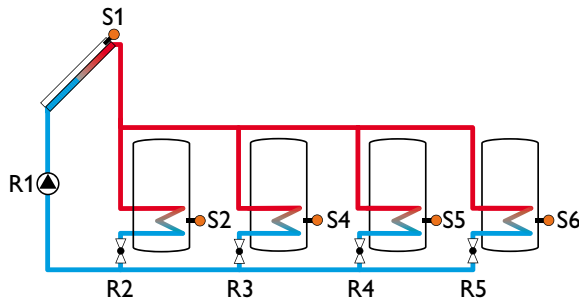

### Relay / sensor allocation

	1	2	3	4	5	6	7	8	9	10-14
Relay	Solar pump	2PV tank 1	2PV tank 2	2PV tank 3	2PV tank 4	Optional function	Optional function	Optional function	Optional function	Optional function
Sensor	Collector 1	Tank 1 bottom	Free	Tank 2 bottom	Tank 3 bottom	Tank 4 bottom	Free	Free	Free	Free

### System 7 variant 2

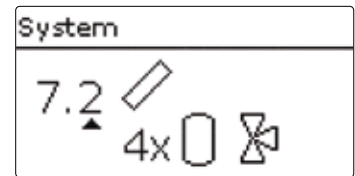
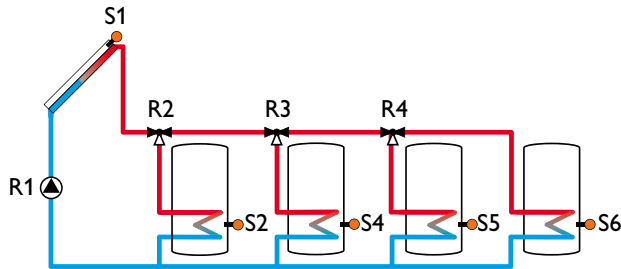

### Relay / sensor allocation

	1	2	3	4	5	6	7	8	9	10-14
Relay	Solar pump	3PV tank 1	3PV tank 2	3PV tank 3	Optional function	Optional function	Optional function	Optional function	Optional function	Optional function
Sensor	Collector 1	Tank 1 bottom	Free	Tank 2 bottom	Tank 3 bottom	Tank 4 bottom	Free	Free	Free	Free



### System 7 variant 3

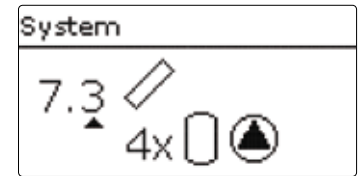
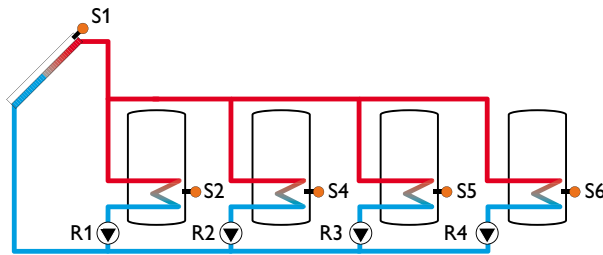

### Relay / sensor allocation

	1	2	3	4	5	6	7	8	9	10-14
Relay	Solar pump tank 1	Solar pump tank 2	Solar pump tank 3	Solar pump tank 4	Optional function	Optional function	Optional function	Optional function	Optional function	Optional function
Sensor	Collector 1	Tank 1 bottom	Free	Tank 2 bottom	Tank 3 bottom	Tank 4 bottom	Free	Free	Free	Free

### System 8 variant 1

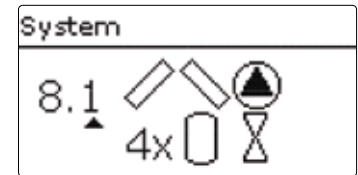
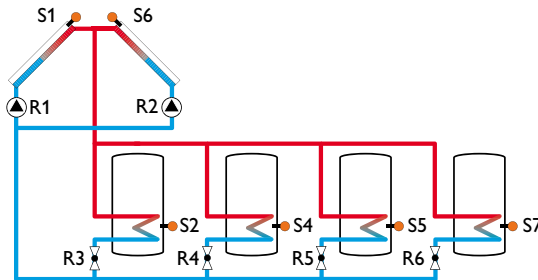

### Relay / sensor allocation

	1	2	3	4	5	6	7	8	9	10-14
Relay	Pump coll. 1	Pump coll. 2	2PV tank 1	2PV tank 2	2PV tank 3	2PV tank 4	Optional function	Optional function	Optional function	Optional function
Sensor	Collector 1	Tank 1 bottom	Free	Tank 2 bottom	Tank 3 bottom	Collector 2	Tank 4 bottom	Free	Free	Free

### System 8 variant 2

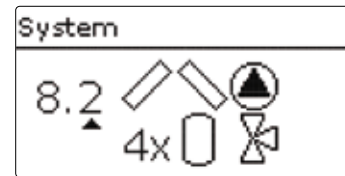
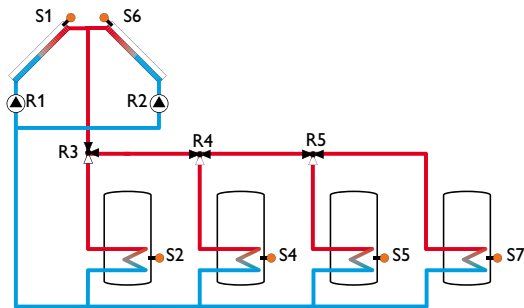

### Relay / sensor allocation

	1	2	3	4	5	6	7	8	9	10-14
Relay	Pump coll. 1	Pump coll. 2	3PV tank 1	3PV tank 2	3PV tank 3	Optional function	Optional function	Optional function	Optional function	Optional function
Sensor	Collector 1	Tank 1 bottom	Free	Tank 2 bottom	Tank 3 bottom	Collector 2	Tank 4 bottom	Free	Free	Free

### System 8 variant 3

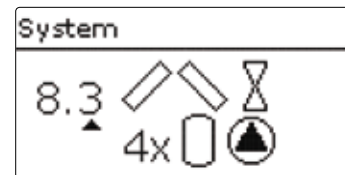
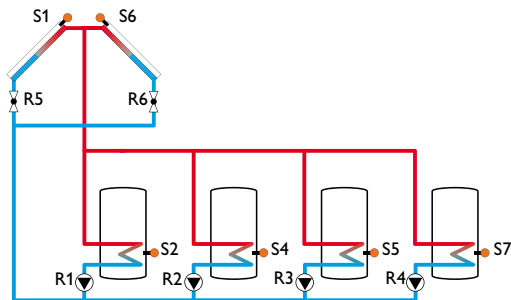

### Relay / sensor allocation

	1	2	3	4	5	6	7	8	9	10-14
Relay	Solar pump tank 1	Solar pump tank 2	Solar pump tank 3	Solar pump tank 4	2PV coll. 1	2PV coll. 2	Optional function	Optional function	Optional function	Optional function
Sensor	Collector 1	Tank 1 bottom	Free	Tank 2 bottom	Tank 3 bottom	Collector 2	Tank 4 bottom	Free	Free	Free

### System 8 variant 4

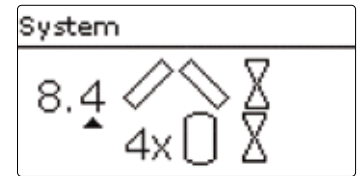
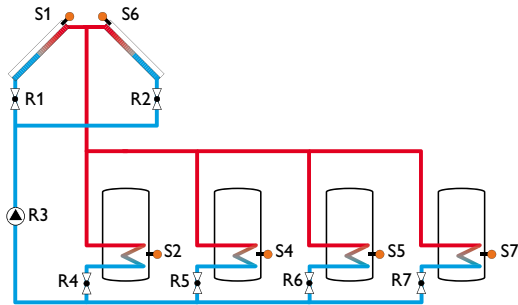

### Relay / sensor allocation

	1	2	3	4	5	6	7	8	9	10-14
Relay	2PV coll. 1	2PV coll. 2	Solar pump	2PV tank 1	2PV tank 2	2PV tank 3	2PV tank 4	Optional function	Optional function	Optional function
Sensor	Collector 1	Tank 1 bottom	Free	Tank 2 bottom	Tank 3 bottom	Collector 2	Tank 4 bottom	Free	Free	Free

### System 8 variant 5

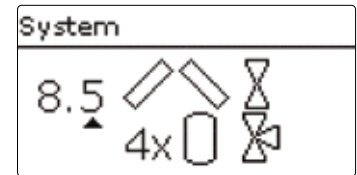
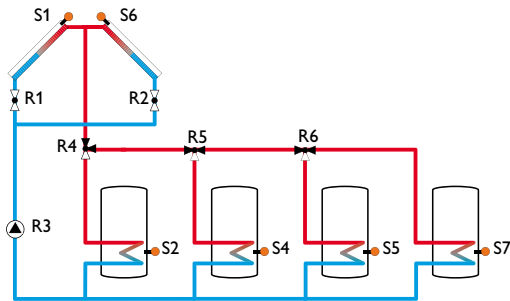

### Relay / sensor allocation

	1	2	3	4	5	6	7	8	9	10-14
Relay	2PV coll. 1	2PV coll. 2	Solar pump	3PV tank 1	3PV tank 2	3PV tank 3	Optional function	Optional function	Optional function	Optional function
Sensor	Collector 1	Tank 1 bottom	Free	Tank 2 bottom	Tank 3 bottom	Collector 2	Tank 4 bottom	Free	Free	Free

### System 9 variant 1

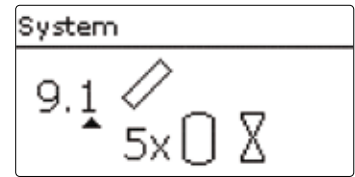
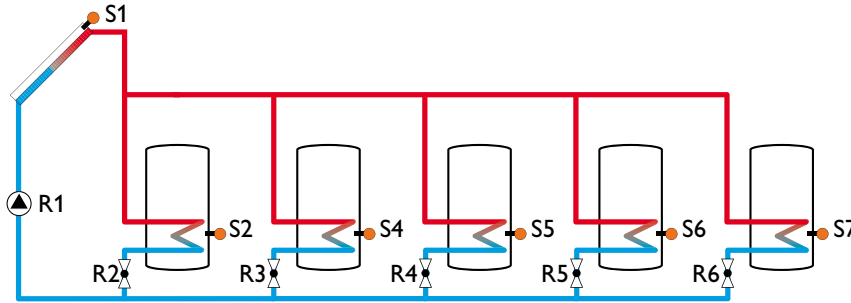

### Relay / sensor allocation

	1	2	3	4	5	6	7	8	9	10-14
Relay	Solar pump	2PV tank 1	2PV tank 2	2PV tank 3	2PV tank 4	2PV tank 5	Optional function	Optional function	Optional function	Optional function
Sensor	Collector 1	Tank 1 bottom	Free	Tank 2 bottom	Tank 3 bottom	Tank 4 bottom	Tank 5 bottom	Free	Free	Free

### System 9 variant 2

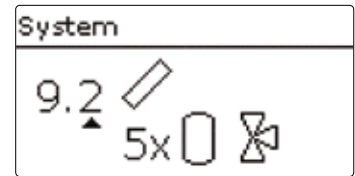
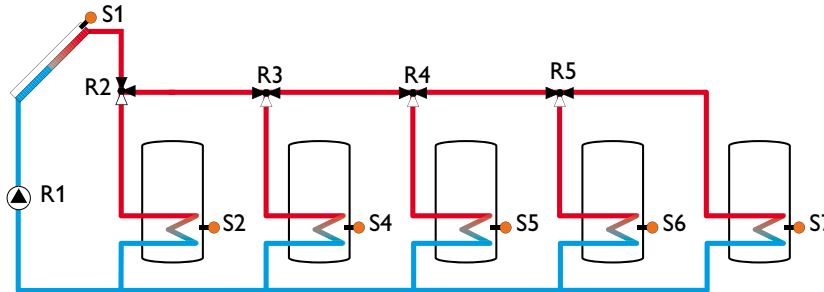

### Relay / sensor allocation

	1	2	3	4	5	6	7	8	9	10-14
Relay	Solar pump	3PV tank 1	3PV tank 2	3PV tank 3	3PV tank 4	Optional function	Optional function	Optional function	Optional function	Optional function
Sensor	Collector 1	Tank 1 bottom	Free	Tank 2 bottom	Tank 3 bottom	Tank 4 bottom	Tank 5 bottom	Free	Free	Free

### System 9 variant 3

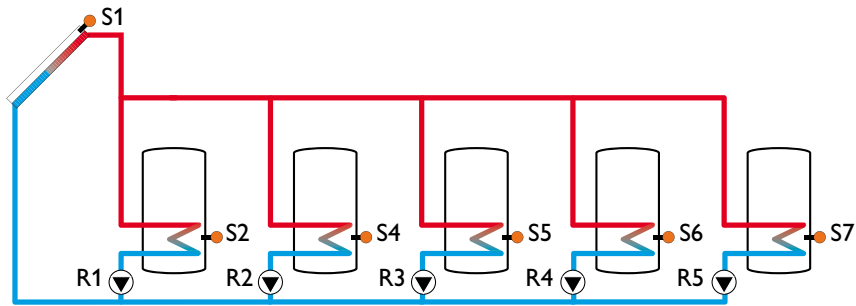

System

9.3

5x

### Relay / sensor allocation

	1	2	3	4	5	6	7	8	9	10-14
Relay	Solar pump tank 1	Solar pump tank 2	Solar pump tank 3	Solar pump tank 4	Solar pump tank 5	Optional function	Optional function	Optional function	Optional function	Optional function
Sensor	Collector 1	Tank 1 bottom	Free	Tank 2 bottom	Tank 3 bottom	Tank 4 bottom	Tank 5 bottom	Free	Free	Free

en

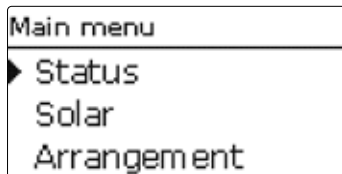

## 6 Main menu



During normal operation, the display of the controller shows the main menu. From here, the different menu areas can be selected.

The following menus are available:

- Status
- Solar
- Arrangement
- Heating
- HQM
- Basic settings
- SD card
- Manual mode
- User code
- In- / Outputs
- Expert

- ➔ Select the menu area by pressing buttons  and 
- ➔ Press button  in order to enter the selected menu



### Note

When no button is pressed for 1 minute, the display illumination stops. After 3 more minutes, the controller switches into the Status menu.

- ➔ In order to access the main menu, press button .

## 7 Status

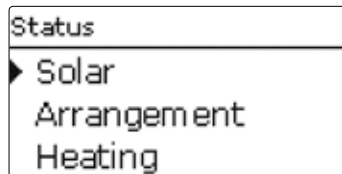

In the **Status** menu, the status messages for every menu area can be found.

### 7.1 Solar

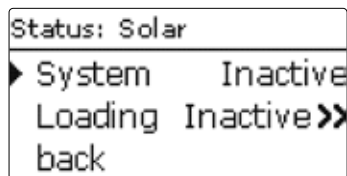

In the **Status / Solar** menu, the status of the solar system, the solar loading and the selected optional functions are indicated.

### 7.2 Arrangement

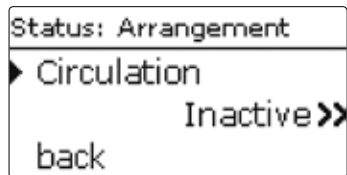

In the **Status / Arrangement** menu, the status of the selected optional functions is indicated.

## 7.3 Heating

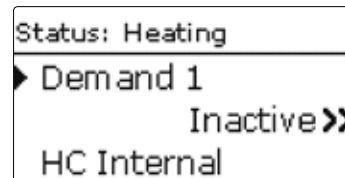

In the **Status / Heating** menu, the status of the demands and heating circuits activated as well as of the selected optional functions is indicated.

### 7.4 Messages

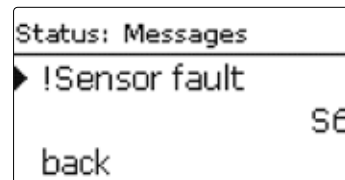

In the **Status / Messages** menu, error and warning messages which have not been acknowledged are indicated.

During normal operation, the message **Everything OK** is indicated.

A line break or short circuit in a sensor line is indicated as **!Sensor fault**. A precise error code can be found in the **Status / Meas.- / Balance values** menu.

If the optional function Flow rate monitoring is activated and has detected an error, the message **!Flow r. monit.** is indicated.

All messages will additionally be displayed in the corresponding menus. In order to acknowledge an error message, the corresponding menu has to be entered. If, for example, the message **!Flow r. monit.** appears, it will also be displayed in the **Solar / Optional functions / Flow rate monitoring**. In that menu, the message can be acknowledged.

## 7.5 Meas. / Balance values

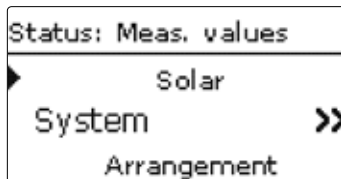

In the **Status / Meas. / Balance values** menu, all current measurement values as well as a range of balance values are displayed. Some of the menu items can be selected in order to enter a submenu.

Additionally, all optional functions selected, the operating hours counter as well as activated heat quantity measurements are displayed.

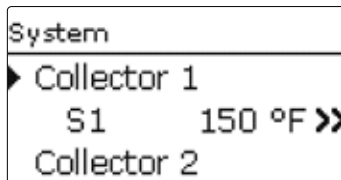

If, for example, **Solar / System** is selected, a submenu with the sensors and relays allocated to the solar system opens. In the submenu, the current temperatures and the current pump speed are displayed.

When a line with a measurement value is selected, another submenu will open.

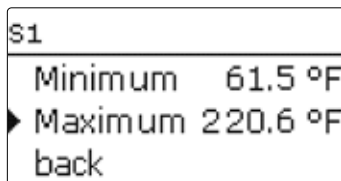

If, for example, S1 is selected, a submenu indicating the minimum and maximum values will open.

When the item **Chart** is selected, a progression chart appears.

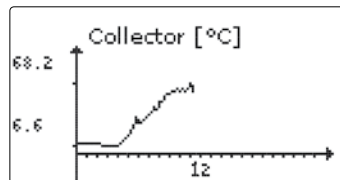

The progression chart shows the development of the temperature at the corresponding sensor over the last 24 hours. Press buttons  $\rightarrow$  and  $\leftarrow$  to switch back and forth between a chart of the current day and one of the day before.

## 7.6 Service

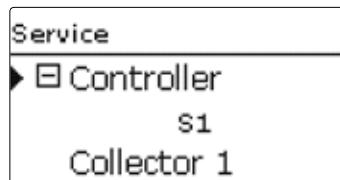

In the **Status / Service** menu, each sensor and relay is indicated with the component or function it has been allocated to. For free sensors and relays, **Free** is indicated.

## 8 Solar

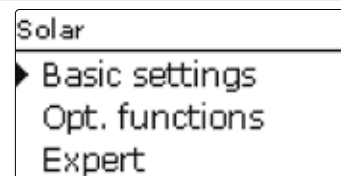

In this menu, all adjustments for the solar part of the arrangement can be made. The Solar menu consists of the following submenu:

- Basic settings
- Optional functions
- Expert

### 8.1 Basic solar settings

In the **Basic settings** menu, all basic settings for the solar part of the arrangement can be adjusted.

In this menu, the hydronic system, which is the basis for the arrangement, can be adjusted. The setting is divided into systems and variants.

Both system and variant have usually been adjusted during commissioning. If the setting is changed later on, all adjustments for the solar part of the arrangement are set back to their factory settings.

If the change causes the new solar system to require a relay that has been allocated to an arrangement function before, all adjustments made in the non-solar part will be set back to their factory settings as well.

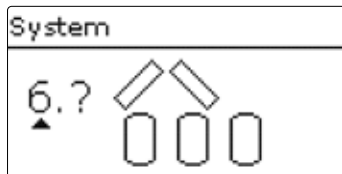

First of all, the basic solar system can be selected according to the number of stores and collector fields in use. The corresponding numbers are indicated on the display.

The exemplary figure shows system 6 with its 3 stores and 2 collector fields (east- / west collectors).

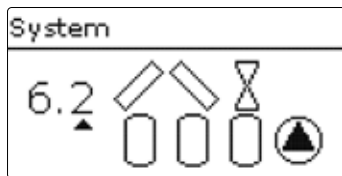

When the basic system has been selected and confirmed, the hydronic variant can be selected. The variant is visualized on the display by means of pump and valve symbols. The exemplary figure shows variant 2 of system 6 with a 2-port valve and a pump. For an overview of the basic systems and their variants see chap. 5.2 on page 15.

The controller supports up to 2 collector fields and up to 5 solar stores (with 2 collector fields only up to 4 solar stores).

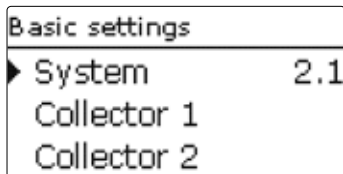

The following items in the Solar / Basic settings menu will adjust to the system selected.

### Collector (1/2)

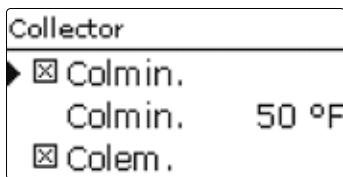

In systems with 2 collector fields, 2 separate menu items (**Collector 1** and **Collector 2**) are displayed instead of **Collector**.

For each collector field, a collector minimum limitation and a collector emergency shutdown temperature can be adjusted.

### Solar / Basic settings / Collector (1/2)

Adjustment channel	Description	Adjustment range / selection	Factory setting
Colmin.	Minimum collector limitation	Yes, No	Yes
Colmin.	Minimum collector temperature	10 ... 90 °C [50 ... 194 °F]	10 °C [50 °F]
Colem.	Collector emergency shutdown	Yes, No	Yes
Colem.	Collector emergency temperature	80 ... 200 °C [176 ... 392 °F]	130 °C [266 °F]



## Store (1 / 2 / 3 / 4 / 5)

Store	
▶ ΔTon	12.0 °Ra
ΔToff	8.0 °Ra
ΔTset	20.0 °Ra

In systems with 2 or more stores, the corresponding number of separate menu items (**Store 1** to **Store 5**) is displayed instead of **Store**.

For each store, an individual ΔT control, a set and a maximum temperature, the priority, a hysteresis, a rise value, a minimum runtime and a minimum pump speed can be adjusted.

In multi-store-systems with differing Store set / Maximum store temperatures, all stores are loaded up to their Stset temperatures first (according to their priority and the store sequence control). Only when all stores have exceeded **Stset** will they be loaded up to their **Stmax** temperatures, again according to their priority and the store sequence control.

## Solar / Basic settings / Store (1 / 2 / 3 / 4 / 5)

Adjustment channel	Description	Adjustment range / selection	Factory setting
ΔTon	Switch-on temperature difference	1.0 ... 20.0 K [2.0 ... 40.0°Ra]	6.0 K [12.0 °Ra]
ΔToff	Switch-off temperature difference	0.5 ... 19.5 K [1.0 ... 39.0°Ra]	4.0 K [8.0 °Ra]
ΔTset	Set temperature	1.5 ... 30.0 K [1.5 ... 60.0°Ra]	10.0 K [20.0 °Ra]
Stset	Store set temperature	4 ... 95 °C [40 ... 204 °F]	45 °C [114 °F]
Stmax	Maximum store temperature	4 ... 95 °C [40 ... 204 °F]	60 °C [140 °F]
Priority	Priority	1	1 ... 5 (system-dependent)
HysSt	Hysteresis maximum store temperature	0.1 ... 10.0 K [0.2 ... 20.0°Ra]	2.0 K [4.0 °Ra]
Rise	Rise	1.0 ... 20.0 K [2.0 ... 40.0°Ra]	2.0 K [4.0 °Ra]
tmin	Minimum runtime	0 ... 300	180
Min speed.	Minimum speed	30 ... 100 %	30 %
Deactivated	Blocked for solar loading	Yes, No	No

## Loading logic

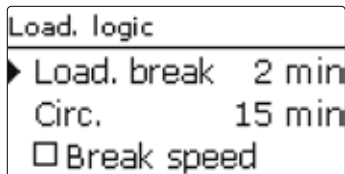

In systems with 2 or more stores, loading logic adjustments can be made in this menu.

In systems 1 and 2, only the menu item **Pump delay** will be available.

If the priority store cannot be loaded, the subordinate store next in priority is checked. If useful heat can be added, it will be loaded for the circulation time (**Circ.** – factory setting 15 min.) After this, the loading

process stops and the controller monitors the increase in collector temperature during the loading break time **Load. break**. If it increases by 2 K [4° Ra], the break time timer starts again to allow the collector to gain more heat. If the collector temperature does not increase sufficiently, the subordinate store will be loaded again for the **Circ.** time as before.

As soon as the switch-on condition of the priority store is fulfilled, it will be loaded. If the switch-on condition of the priority store is not fulfilled, loading of the second store will be continued. If the priority store reaches its maximum temperature, sequence controlled loading will not be carried out.

If store sequence control is active and the system switches to load the priority store, the parameter **Load. break** also acts as a stabilization timer, during which the switch-off condition is ignored while the system operation stabilizes.

## Solar / Basic settings / Loading logic

Adjustment channel	Description	Adjustment range / selection	Factory setting
Load. break	Loading break time	1 ... 5	2
Circ.	Circulation time	1 ... 60	15
Break speed	Pause speed	Yes, No	No
Speed	Pause speed	30 ... 100 %	30 %
Pump delay	Pump delay	Yes, No	No
Delay	Delay time	5 ... 600	15

## 8.2 Solar optional functions

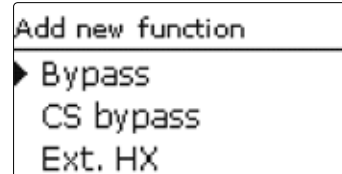

In this menu, additional functions can be selected and adjusted for the solar part of the arrangement.

By selecting **Add new function...**, different pre-programmed functions can be selected. The optional functions are available as long as free relays are available.

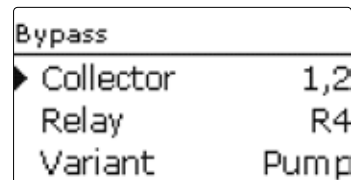

When a function is selected, a submenu opens in which all adjustments required can be made.

With this menu item, a relay and, if necessary, certain system components can be allocated to the function.

**Relay selec.ControllerOpt. functionsAdd new function...Status/Service**

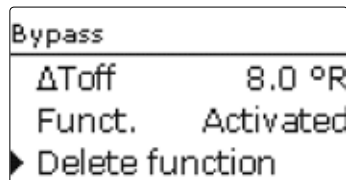

At the end of each optional function submenu, the menu items **Funct.** and **Delete function** are available.

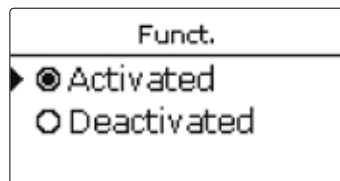

With the menu item **Funct.**, an optional function already selected can be temporarily deactivated or re-activated respectively. All adjustments remain stored, the allocated relays remain occupied and cannot be allocated to another function.

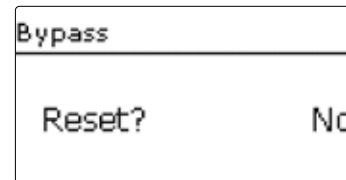

If the menu item **Delete function** is confirmed by pressing button 5, a security enquiry appears. The setting can be changed between **Yes** and **No** by pressing buttons 2 and 4. If **Yes** has been selected and confirmed by pressing button 5, the function is deleted and available under **Add new function...** again. The corresponding relays are available again.

**Bypass**

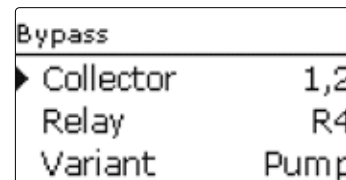

In order to prevent energy from being extracted from the store when starting store loading, this function makes sure that the cold fluid in the pipes is diverted past the store via a bypass (valve or pump). Once the pipe is warm enough, the store can be loaded. The switch-on conditions can be adjusted individually.

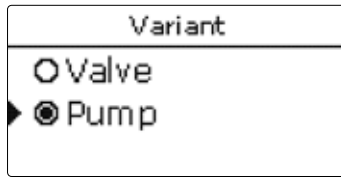

### Variant pump:

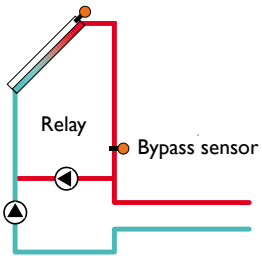

### Variant valve:

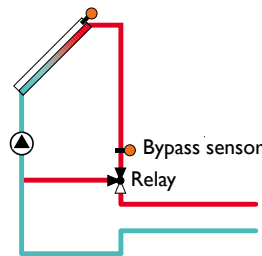

Exemplary schematics for the bypass variants

Depending on whether the bypass is energized by a valve or by a second pump, a corresponding adjustment can be made in the menu item **Variant**. Depending on the variant, different control logics are applied:

#### Pump:

In this version, a bypass pump is placed in front of the collector pump.

The bypass pump is first activated when store loading is possible. If the switch-on condition is fulfilled, the bypass pump is switched off and the collector circuit pump is activated.

#### Valve:

A bypass valve is placed into the solar circuit.

The solar heat exchanger is first bypassed when store loading is possible. If the above-mentioned switch-on condition is fulfilled, the bypass relay switches the collector circuit via the heat exchanger.

### Solar / Opt. functions / Add new function.../ Bypass

Adjustment channel	Description	Adjustment range / selection	Factory setting
Collector	Collector field	system dependent	system dependent
Relay	Bypass relay	system dependent	system dependent
Variant	Variant (pump or valve logic)	pump, valve	pump
Sensor	Bypass sensor	system dependent	system dependent
$\Delta T_{on}$	Switch-on temperature difference	1.0 ... 20.0 K [2.0 ... 40.0 °Ra]	6.0 K [12.0 °Ra]
$\Delta T_{off}$	Switch-off temperature difference	0.5 ... 19.5 K [1.0 ... 39.0 °Ra]	4.0 K [8.0 °Ra]
Funct.	Activation / Deactivation	Activ., Deactivated	Activ.

## CS bypass

CS bypass	
▶ Collector	1,2
Irrad.	200 W/m <sup>2</sup>
Delay	120 s

The CS bypass function is a different possibility to activate the collector circuit bypass. To enable the use of the CS bypass function, a CS10 irradiation sensor has to be connected.

When the CS bypass function is activated, the irradiation value is the switch-on condition for the collector circuit bypass.

The relay remains switched on if the **Irrad.** value is exceeded for the **Delay** time. When solar loading begins or the irradiation value remains below the switch-on value for the delay time, the relay is switched off.

## Solar / Opt. functions / Add new function.../ CS bypass

Adjustment channel	Description	Adjustment range / selection	Factory setting
Collector	Collector field	system dependent	system dependent
Irrad.	Switch-on irradiation	100 ... 500 W/m <sup>2</sup>	200 W/m <sup>2</sup>
Delay	Delay time	10 ... 300 s	120 s
Funct.	Activation / Deactivation	Activ., Deactivated	Deactivated

## Tube collector function

Tube collector	
▶ Start	08:00
Stop	19:00
Run	30 s

### Solar / Opt. functions / Add new function.../Tube collector

Adjustment channel	Description	Adjustment range / selection	Factory setting
Start	Start time frame	00:00 ... 23:00	08:00
Stop	Stop time frame	00:30 ... 23:30	19:00
Run	Pump runtime	5 ... 600 s	30 s
Break	Break	1 ... 60 min	30 min
Delay	Pump delay	5 ... 600 s	30 s
Collector	Collector field	system dependent	system dependent
Funct.	Activation / Deactivation	Activ., Deactivated	Deactivated

This function helps overcome the non-ideal sensor position with some evacuated tube collectors.

This function operates within an adjusted time frame. It activates the collector circuit pump for an adjustable runtime between adjustable pauses in order to compensate for the delayed temperature measurement.

If the runtime is set to more than 10 s, the pump will be run at 100 % for the first 10 s of the runtime. For the remaining runtime, the pump will be run at the adjusted minimum speed.

If the collector sensor is defective or the collector is blocked, this function is suppressed or switched off.

#### 2-collector systems

In 2-collector systems, the evacuated tube collector function is available for each individual collector field.

If one of the collector fields is being loaded, the heat transfer fluid flows through the inactive field and only the corresponding relay is energized.

#### Multi-store systems

If the evacuated tube collector function is activated, the speed of the solar pump will decrease to the minimum speed during the loading break time. The solar loading of the subordinate store will continue.

In 2-collector systems, during the loading break time, the collector field which has been active before the loading break time remains active during the loading break time, unless the evacuated tube collector function of the inactive field becomes active.

## Target temperature

Target temp.	
▶ Targ. temp.	150 °F
Sensor	S9
Rise	4.0 °R

### Solar / Opt. functions / Add new function.../Target temperature

Adjustment channel	Description	Adjustment range / selection	Factory setting
Targ. temp.	Target temperature	20 ... 110 °C [68 ... 230 °F]	65 °C [150 °F]
Sensor	Reference sensor	system dependent	system dependent
Rise	Rise	1.0 ... 20.0 K [2.0 ... 40.0 °Ra]	2.0 K [4.0 °Ra]
Funct.	Activation / Deactivation	Activ., Deactivated	Deactivated

## Antifreeze

Antifreeze	
▶ Frost on	40 °F
Frost off	44 °F
Collector	1

### Solar / Opt. functions / Add new function.../Antifreeze

Adjustment channel	Description	Adjustment range / selection	Factory setting
Frost on	Antifreeze switch-on temperature	-40 ... +15 °C [-40 ... +58 °F]	+4 °C [+40 °F]
Frost off	Antifreeze switch-off temperature	-39 ... +16 °C [-39 ... +60 °F]	+6 °C [+44 °F]
Collector	Collector field	system dependent	system dependent
Store (1 ... 5)	Store succession order	system dependent	system dependent
Funct.	Activation / Deactivation	Activ., Deactivated	Deactivated

When the **Target temperature** function is activated, the pump speed control logic changes. The controller will remain at the minimum pump speed until the temperature at the allocated sensor exceeds the adjusted target temperature. Only then will the standard pump speed control start to operate. If the temperature at the allocated sensor changes by the adjusted **Rise** value, the pump speed will be adjusted correspondingly.

If the **Ext. HX** (see page 43) function has been activated, too, the target temperature control will pause while the external heat exchanger is loaded. While the external heat exchanger is loaded, its own pump speed control will come into effect.

As soon as the temperature at the collector is 4 °C [40 °F], the antifreeze function operates the loading circuit between the collector and the 1st store in order to protect the heat transfer fluid in the loading circuit against freezing or coagulation.

If the collector temperature exceeds 6 °C [44 °F], this function is switched off.

Heat will be extracted from the stores according to the adjusted order. If all stores have reached their minimum temperature of 5 °C [42 °F], the function becomes inactive.

The minimum pump speed is set to 100%.

In 2-collector systems, the antifreeze menu is extended. The adjustment channels are separated numerically.

## Afterheating suppression

AH Suppression	
▶ Relay	R5
Store	1,2
<input type="checkbox"/> Tset	

### Solar / Opt. functions / Add new function.../ AH suppress.

Adjustment channel	Description	Adjustment range / selection	Factory setting
Relay	Reference relay	system dependent	system dependent
Store	Sensor selection	system dependent	system dependent
Tset	Set temperature	Yes, No	No
Funct.	Activation / Deactivation	Activ., Deactivated	Deactivated

## Parallel relay

Parallel relay	
▶ Relay	R6
Store	1
Funct.	Activated

### Solar / Opt. functions / Add new function.../ Parallel relay

Adjustment channel	Description	Adjustment range / selection	Factory setting
Relay	Parallel relay	system dependent	system dependent
Store	Sensor selection	system dependent	system dependent
Funct.	Activation / Deactivation	Activ., Deactivated	Deactivated

The afterheating suppression blocks the conventional afterheating of a store that is currently in solar loading. This function is activated if a previously selected **Store** is being loaded.

Solar loading means that store loading is only carried out for energy supply and not for cooling purposes etc. If the **Tset** option is activated, the backup heating will only be suppressed when the store temperature exceeds Tset.

With this function, e. g. a valve can be controlled in parallel to a solar pump via a separate relay.

Switch-on condition for the solar parallel relay function is that one or more of the selected stores is being loaded. If at least one of the selected stores is being loaded, the parallel relay is energized.

The parallel relay function operates regardless whether the store is subjected to regular solar loading or to a loading caused by an optional function (such as the collector cooling).



#### Note:

If a relay is in the manual mode, the selected parallel relay will not be energized.



## Cooling mode

In the cooling mode menu, different cooling functions are available. They can be used for keeping the solar system operational for a longer time during strong solar irradiation.

For this purpose, the adjusted maximum store temperatures can be exceeded. The store order for this overloading can be adjusted. Additionally, each individual store can be excluded from this function.

Two different variants are available for the cooling mode: the system cooling and the collector cooling.

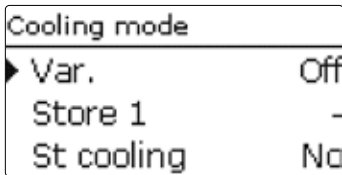

### System cooling:

If the system cooling variant has been selected and the switch-on temperature difference is exceeded, store loading is continued even if the corresponding maximum temperature is exceeded, but only up to the emergency shutdown temperature. Store loading continues until all stores have reached the emergency shutdown temperature or until the switch-off temperature difference is reached.

### Collector cooling:

If the collector cooling variant has been selected, store loading is continued or reactivated when the collector maximum temperature is exceeded.

Store loading continues until all stores have reached the emergency shutdown temperature or until the collector temperature falls below the collector maximum temperature by at least 5 K.

In 2-collector systems, separate adjustments can be made for each collector field.

The control logic regards collector cooling operation as solar loading. The adjusted values for delay, minimum runtime, etc. remain valid.

In addition to the cooling mode, store cooling is available.

### Store cooling:

When the store cooling function is activated, the controller aims to cool down the store during the night in order to prepare it for solar loading on the following day.

When the store cooling function is activated, the solar pump is switched on if the maximum store temperature is exceeded and the collector temperature falls below the store temperature. The solar pump remains active until the store temperature falls below the adjusted maximum store temperature.

The store order for the cooling is the same as in the overheating through system- or collector cooling.

The holiday function works like the store cooling function but aims to cool the store further down during times without DHW consumption in order to prepare it for solar loading on the following day.

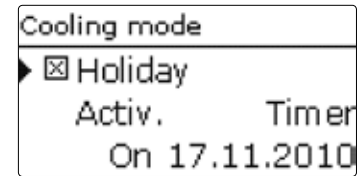

This function can only be activated if the store cooling function is activated.

The holiday function can either be activated manually when a phase with no DHW consumption begins, or a time frame, during which the function is to become active, can be set in advance. If **manual** is selected, an input can be allocated to the function. When a switch is connected to the allocated input, it will act as an on/off switch for the holiday function.

## Solar / Opt. functions / Add new function.../ Cooling mode

Adjustment channel	Description	Adjustment range / selection	Factory setting
Variant	Cooling logic variant	Col. cool, Syst. cool., Off	Off
Tcolmax.	Collector maximum temperature	70 ... 190 °C [158 ... 374 °F]	100 °C [212 °F]
Store (1 ... 5)	Store order	system dependent	system dependent
St cooling	Store cooling	Yes, No	No
$\Delta T_{on}$	Switch-on temperature difference	1.0 ... 30.0 K [2.0 ... 60.0 °Ra]	20.0 K [40.0 °Ra]
$\Delta T_{off}$	Switch-off temperature difference	0.5 ... 29.5 K [1.0 ... 59.0 °Ra]	15.0 K [30.0 °Ra]
Holiday	Holiday function	Yes, No	No
Activation	Activation mode	Manual, Timer	Timer
On	Holiday function switch-on date	Dates up to 31.12.2099	Current date
Off	Holiday function switch-off date	Dates up to 31.12.2099	Current date
Input	Holiday function switch input	system dependent	system dependent
Stmax (1 ... 5)	Maximum store temperature Holiday function	4 ... 95 °C [40 ... 204 °F]	40 °C [104 °F]

## Solar external heat exchanger

Ext. HX	
▶ Relay	R7
Min speed	30%
Store	1,2

## Solar / Opt. functions / Add new function.../ Ext. HX

Adjustment channel	Description	Adjustment range / selection	Factory setting
Relay	Relay selection	system dependent	system dependent
Min speed	Minimum speed	30 ... 100 %	30 %
Store	Sensor selection	system dependent	1
Sensor HX	Reference sensor ext.HX	system dependent	system dependent
Targ. temp.	Target temperature option	Yes, No	No
Sensor	Target temperature reference sensor	system dependent	system dependent
Targ. temp.	Target temperature	15 ... 95 °C [60 ... 204 °F]	60 °C [140 °F]
ΔTon	Switch-on temperature difference	1.0 ... 20.0 K [2.0 ... 40.0 °Ra]	10.0 K [20.0 °Ra]
ΔToff	Switch-off temperature difference	0.5 ... 19.5 K [1.0 ... 39.0 °Ra]	5.0 K [10.0 °Ra]
Overrun	Overrun time	1 ... 15 min	2 min

This function is used to link loading circuits that are separated by an external heat exchanger.

The allocated relay is energized if one of the selected stores is being loaded and there is a temperature difference between the sensor of the corresponding store and the solar flow.

Any number of the solar stores can be selected.

The relay is switched off if this temperature difference falls below the adjusted switch-off difference.

In contrast to the bypass function, a differential control between **Sensor HX** and the store temperature can be carried out by means of the heat exchanger relay.

The reference sensor can be arbitrarily allocated.

In systems in which stores are equipped with their own loading pumps, the relay “external heat exchanger“ controls the primary circuit pump.

The heat exchanger is protected by a non-adjustable antifreeze function.



### Note:

Because of the special hydraulics, the target temperature option will not work properly in systems with 2 collector fields.

## Drainback option

Drainback	
Filling time	5 min
Stab. time	2.0 min
Initialis.	60 s

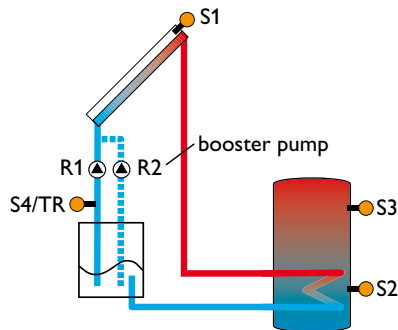

Exemplary drainback system layout  
(R2 = booster pump)

A drainback system permits the heat transfer fluid to drain back into the holding tank when solar energy is not collected. The drainback option will initiate the filling of the system when solar loading begins.



### Note:

The parameter **Filling time** is used to adjust the time period for which the pump will be run at 100 % speed in order to fill the system.

The parameter **Stab. time** is used for adjusting the time period during which the switch-off condition will be ignored after the filling time has ended.

The parameter **Initialis.** is used for adjusting the time period during which the switch-on condition must be permanently fulfilled for the filling procedure to start.

The **Booster** option is used for switching on a second pump when filling the solar system. The corresponding relay is switched on at 100 % speed for the duration of the filling time.

A short time (Delay time) after the system has been emptied, the **Drain impulse** option will switch on the solar pump for an adjustable **Duration**. Thus, a hydrostatic head will form in the flow pipe. When it falls back into the holding tank, water pockets remaining in the collector will be sucked down into the holding tank.

## Solar / Opt. functions / Add new function.../ Drainback

Adjustment channel	Description	Adjustment range / selection	Factory setting
Filling time	Filling time	1 ... 30 min	5 min
Stab. time	Stabilization time	1.0 ... 15.0 min	2,0 min
Initialis.	Initialization time	1 ... 100 s	60 s
Booster	Booster option	Yes, No	No
Relay	Booster pump relay selection	system dependent	system dependent
Drain impulse	Drain impulse option	Yes, No	No
Delay	Delay time	1 ... 30 min	3 min
Duration	Drain impulse loading duration	1 ... 60 s	10 s
Funct.	Activation / Deactivation	Activ., Deactivated	Deactivated

## Twin pump

Twin pump	
Relay	R9
▶ Ref. relay	R6
Runtime	6 h

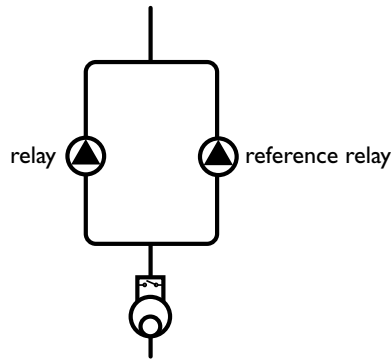

Exemplary figure of twin pumps in the solar flow with upstream flowmeter

## Solar / Opt. functions / Add new function.../Twin pump

Adjustment channel	Description	Adjustment range / selection	Factory setting
Relay	Relay selection	system dependent	system dependent
Ref. relay	Reference relay selection	system dependent	system dependent
Runtime	Pump runtime	1 ... 48 h	6 h
Flow rate mon.	Flow rate monitoring option	Yes, No	No
Flow rate sen.	Flow rate sensor selection	Imp1 ... Imp3, Ga1, Ga2, Gd1, Gd2	Imp1
Delay	Delay time	1 ... 10 min	5 min
Funct.	Activation / Deactivation	Activ., Deactivated	Deactivated

The **Twin pump** function controls the equal distribution of pump runtime in systems with two equally usable pumps.

If the allocated relay has exceeded its adjusted runtime and the next switch-on process is imminent, the reference relay is switched on instead. All characteristics are adopted.

If the reference relay has in turn exceeded its runtime as well, the first relay is switched on again in the next switch-on process.

Additionally, the **Flow rate monitoring** option can be activated in order to activate the twin pump in the case of a flow rate error. When the flow rate monitoring option is activated, two additional adjustment channels appear for allocating a sensor and adjusting a delay time.

If the flow rate monitoring option is activated, an error message will appear when no flow rate is detected at the allocated sensor after the **Delay** time has passed. The active relay is considered as defective and will be blocked until the error message has been acknowledged. The second relay will be activated instead. The twin pump function will pause until the error message has been acknowledged.

When the error message is acknowledged, the controller runs a test during which it will energize the relay and again monitor the flow rate.

## Heat dump

Heat dump	
► Relay	R10
Tcol.	110 °C
Funct.	Activated

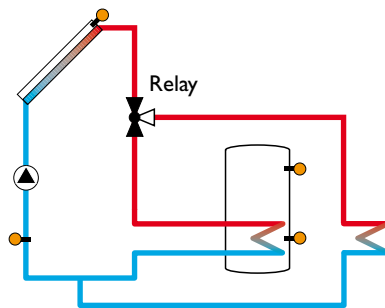

### Note:

The switch-on collector temperature is blocked against the emergency switch-off temperature by 10 K [20 °Ra].

## Solar / Opt. functions / Add new function.../ Heat dump

Adjustment channel	Description	Adjustment range / selection	Factory setting
Relay	Relay selection	system dependent	system dependent
Tcol.	Switch-on collector temperature	40 ... 190 °C [104 ... 374 °F]	110 °C [230 °F]
Funct.	Activation / Deactivation	Activ., Deactivated	Deactivated

## Flow rate monitoring

Flow rate mon.	
Sensor	Imp.1
► Ref. relay	R7
Store	1

## Solar / Opt. functions / Add new function.../ Flow rate mon.

Adjustment channel	Description	Adjustment range / selection	Factory setting
Sensor	Flow rate sensor selection	Imp1 ... Imp3, Ga1, Ga2, Gd1, Gd2	Imp1
Ref. relay	Reference relay selection	system dependent	system dependent
Store	Sensor selection	system dependent	1
Funct.	Activation / Deactivation	Activ., Deactivated	Deactivated

The heat dump function can be used to direct excess heat generated by strong solar irradiation to an external heat exchanger (e. g. fan coil) in order to prevent the collectors from overheating.

The allocated relay is energized with 100%, if the collector temperature reaches the adjusted switch-on temperature. If the collector temperature falls by 5 K below the adjusted collector overtemperature, the relay will be switched off.

If one of the store temperatures exceeds its respective maximum temperature by more than 5 K while the heat dump function is active, the function is deactivated and an error message appears. If the store temperature falls below the maximum store temperature again, the heat dump function is released.

The flow rate monitoring function can be used to detect malfunctions that impede the flow rate and to switch off the corresponding relay. This will prevent system damage, e. g. through a dry run of the pump.

If the flow rate monitoring function is activated, an error message will appear when no flow rate is detected at the allocated flowmeter after the delay time has passed. The store being loaded is blocked for any further loading until the error message has been acknowledged. The next store free for loading will be loaded instead.

The error message will appear both in the **Status / Messages** menu and in the optional function menu. It can only be acknowledged in the optional function menu. When the error message is acknowledged, the controller runs a test during which it will energize the relay and again monitor the flow rate.

### 8.3 Solar expert menu

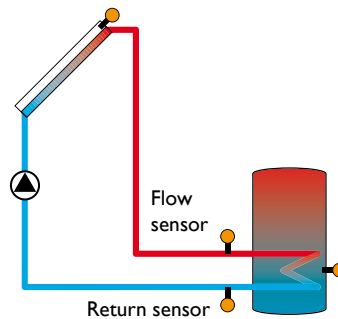
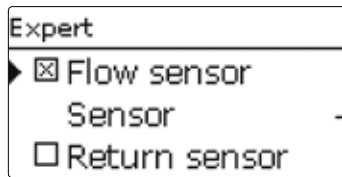

Example of flow- and return sensor positions

#### Solar / Expert

Adjustment channel	Description	Adjustment range / selection	Factory setting
Flow sensor	Flow sensor option	Yes, No	No
Sensor	Flow sensor selection	system dependent	system dependent
Return sensor	Return sensor option	Yes, No	No
Sensor	Return sensor selection	system dependent	system dependent

The expert menu is only available when the expert user code has been entered.

In the expert menu, a flow and a return sensor can be selected and allocated. The activated sensors are used to detect the switch-off conditions.



#### Note:

Because of the special hydraulics, this function will not work properly in systems with 2 collector fields.

### 9 Arrangement

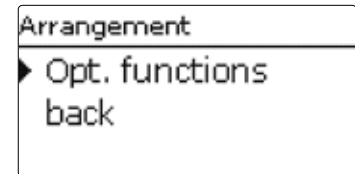

In this menu, all adjustments for the non-solar part of the arrangement can be made.

A range of optional functions can be selected and adjusted.

#### 9.1 Optional functions

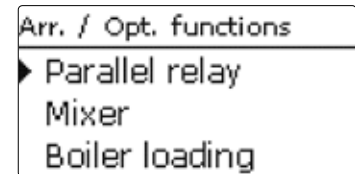

In this menu, additional functions can be selected and adjusted for the arrangement.

By selecting **Add new function...**, different pre-programmed functions can be selected. The optional functions are available as long as free relays are available.

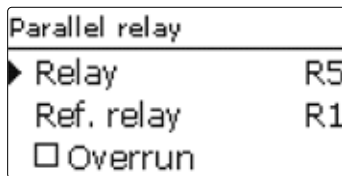

When a function is selected, a submenu opens in which all adjustments required can be made.

With this submenu, a relay and, if necessary, certain system components can be allocated to the function.

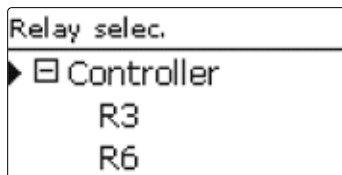

The menu item **Relay selec.** is available in all optional functions. Therefore, it will not be explained in the individual function descriptions.

With this menu item, a relay can be allocated to the function. All free relays are available for selection.

In the submenu **Controller**, all free relays of the controller are displayed. If external modules are connected and registered, their relays will be displayed in corresponding submenus.

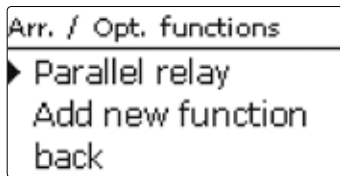

When a function has been selected and adjusted, it will appear in the **Opt. functions** above the menu item **Add new function...**

This allows an easy overview of functions already activated.

An overview about which sensor has been allocated to which component and which relay has been allocated to which function is given in the **Status/Service** menu.

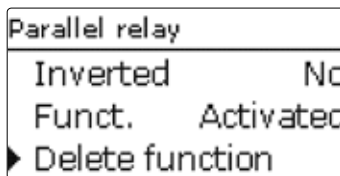

At the end of each optional function submenu, the menu items **Funct.** and **Delete function** are available.

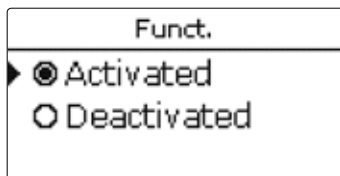

With the menu item **Funct.**, an optional function already selected can be temporarily deactivated or re-activated respectively. All adjustments remain stored, the allocated relays remain occupied and cannot be allocated to another function.

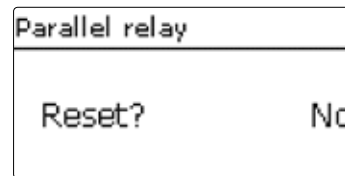

If the menu item **Delete function** is confirmed by pressing button (5), a security enquiry appears. The setting can be changed between **Yes** and **No** by pressing buttons (2) and (4). If **Yes** has been selected and confirmed by pressing button (5), the function is deleted and available under **Add new function...** again. The corresponding relays are available again.

### Parallel relay

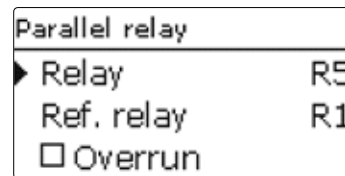

#### Note:

If a relay is in the manual mode, the selected parallel relay will not be energized.



### Arrangement / Opt. functions / Add new function.../ Parallel relay

Adjustment channel	Description	Adjustment range / selection	Factory setting
Relay	Relay selection	system dependent	system dependent
Ref. relay	Reference relay selection	system dependent	system dependent
Overrun	Overrun option	Yes, No	No
Duration	Overrun time	1 ... 30 min	1 min
Delay	Delay option	Yes, No	No
Duration	Delay time	1 ... 30 min	1 min
Inverted	Inverted switching option	Yes, No	No
Funct.	Activation / Deactivation	Activ., Deactivated	Deactivated

### Mixer

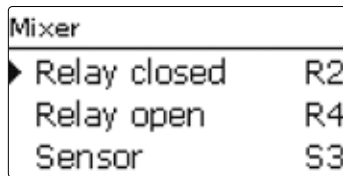

### Arrangement / Opt. functions / Add new function.../ Mixer

Adjustment channel	Description	Adjustment range / selection	Factory setting
Relay closed	Relay selection mixer closed	system dependent	system dependent
Relay open	Relay selection mixer open	system dependent	system dependent
Sensor	Sensor selection	system dependent	system dependent
TMixer	Mixer target temperature	0 ... 130 °C [32 ... 266 °F]	60 °C [140 °F]
Interval	Mixer interval	1 ... 20 s	4 s
Runtime	Mixer runtime	10 ... 600 s	240 s
Offset	Automatic adaption of the mixer runtime	-	-
Time	Adjustment time	00:00 ... 23:30	23:30
Funct.	Activation / Deactivation	Activ., Deactivated	Deactivated

The **Parallel relay** function can be used to operate an allocated parallel relay alongside a selected reference relay. With this function, e. g. a valve can be controlled in parallel to the pump via a separate relay. If the **Overrun** option is activated, the parallel relay remains switched on for the adjusted duration time after the reference relay has been switched off.

If the **Delay** option is activated, the parallel relay will be energized after the adjusted duration has expired. If the reference relay is switched off again during the delay time, the parallel relay will not be switched on at all.

If the **Inverted** option is activated, the parallel relay switches on when the reference relay switches off and vice versa.

The mixer function can be used to adjust the actual flow temperature to the desired mixer target temperature **TMixer**. The mixer is opened or closed in pulses depending on this deviation. The pulses are determined by the adjustable **Interval**. The pause is determined by the difference between the actual value and the set value.

The mixer runtime can either be adjusted in the channel **Runtime** or automatically adapted with the **Offset** function. When **Offset** is selected, the mixer will close first. When button (5) is pressed, the mixer opens and the seconds are counted in the display. As soon as the mixer has reached its open position, press button (5) again. The time measured will automatically appear as the value for the channel **Runtime**.

Once per day, the mixer will automatically adjust itself. The exact **Time** for that can be adjusted.

## Boiler loading

Boiler loading	
► Relay	R5
Sensor top	S4
Sensor base	S5

The boiler loading function can be used to load a store zone between 2 sensors. For the monitoring of switch-on and switch-off conditions, 2 sensors are used. The switch-on and switch-off temperatures **TBoiler on** and **TBoiler off** are used as reference parameters.

If the measured temperatures at both allocated sensors fall below the adjusted switching threshold **TBoiler on**, the relay is energized. It is switched off again when the temperature at both sensors has exceeded **TBoiler off**.

If one of the two sensors is defective, store loading is suppressed or switched off.

Timer: Monday			
00:00	03:00	06:00	09:00
----- ----- ----- -----			
----- ----- ----- -----			
12:00	15:00	18:00	21:00

When the **Timer** option is activated, a timer is indicated in which time frames for the function can be adjusted.

First of all, an overview of the current adjustment is displayed. For each day of the week there is an overview display. The display can be switched back and forth between the different days by pressing buttons **2** or **4**.

In order to adjust the timer, press button **5**.

First the individual days of the week or all days of the week can be selected. The last menu item after the list of days is **Continue**. If **Continue** is selected, the **Edit timer** menu opens, in which the time frames can be adjusted.

Days of the week	
► All days	
<input type="checkbox"/> Monday	
<input type="checkbox"/> Tuesday	

The time frames can be adjusted in steps of 15 minutes. The cursor can be moved along the time line by pressing buttons **2** or **4**. The beginning of a time frame can be determined by pressing button **1**. The end of a time frame can be determined by pressing button **3**.

Edit timer			
00:00	03:00	06:00	09:00
----- ----- ----- -----			
00:00	----- ----- ----- -----		
----- ----- ----- -----			
12:00	15:00	18:00	21:00

## Arrangement / Opt. functions / Add new function.../ Boiler loading

Adjustment channel	Description	Adjustment range / selection	Factory setting
Relay	Relay selection	system dependent	system dependent
Sensor top	Top sensor selection	system dependent	system dependent
Sensor base	Base sensor selection	system dependent	system dependent
TBoiler on	Boiler switch-on temperature	0 ... 94 °C [32 ... 202 °F]	45 °C [114 °F]
TBoiler off	Boiler switch-off temperature	1 ... 95 °C [34 ... 204 °F]	60 °C [140 °F]
Timer	Timer option	Yes, No	No
Timer	Timer	-	-
Days of the week	Day selection	All days, Monday ... Sunday, Continue	-
Timer	Time frame adjustment	00:00 ... 23:45	-
Funct.	Activation / Deactivation	Activ., Deactivated	Deactivated

### Error relay

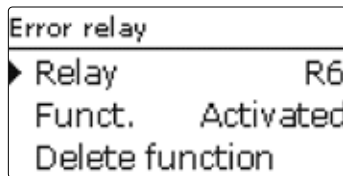

The error relay function can be used to operate a relay in the case of an error. Thus, e. g. a signaling device can be connected to signal errors.

If the error relay function is activated, the allocated relay will be energized when a sensor fault occurs. If the flow rate monitoring function is activated, the error relay will additionally be energized in the case of a flow rate error.

## Arrangement / Opt. functions / Add new function.../ Error relay

Adjustment channel	Description	Adjustment range / selection	Factory setting
Relay	Relay selection	system dependent	system dependent
Funct.	Activation / Deactivation	Activ., Deactivated	Deactivated

## Heat exchange

Heat exchange	
Relay	R6
Sen. Source	S5
Sen. Sink	S6

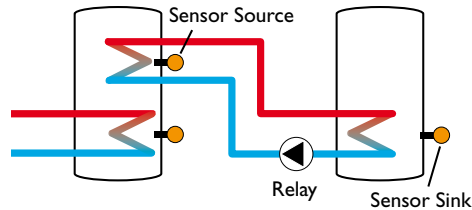

The heat exchange function can be used for transferring heat from a heat source to a heat sink.

The allocated relay is energized when all switch-on conditions are fulfilled:

- the temperature difference between the allocated sensors has exceeded the switch-on temperature difference
- the temperature at the heat source sensor has exceeded the minimum temperature
- the temperature at the heat sink sensor has fallen below the maximum temperature

If  $\Delta T_{set}$  is exceeded, pump speed control will come into effect. For every deviation of 2 K [4 °Ra], the pump speed will be adjusted by 10 %.

### Arrangement / Opt. functions / Add new function.../ Heat exchange

Adjustment channel	Description	Adjustment range / selection	Factory setting
Relay	Relay selection	system dependent	system dependent
Sen. So.	Heat source sensor selection	system dependent	system dependent
Sen. Sink	Heat sink sensor selection	system dependent	system dependent
$\Delta T_{on}$	Switch-on temperature difference	1.0 ... 30.0 K [2.0 ... 60.0 °Ra]	6.0 K [12.0°Ra]
$\Delta T_{off}$	Switch-off temperature difference	0.5 ... 29.5 K [1.0 ... 59.0 °Ra]	4.0 K [8.0°Ra]
$\Delta T_{set}$	Set temperature difference	1.5 ... 40.0 K [3.0 ... 80.0 °Ra]	10.0 K [20.0°Ra]
Min. speed	Minimum speed	30 ... 100 %	30 %
$T_{max}$	Maximum temperature of the store to be loaded	10 ... 95 °C [50 ... 204 °F]	60 °C [140 °F]
$T_{min}$	Minimum temperature of the store to be loaded	10 ... 95 °C [50 ... 204 °F]	10 °C [50 °F]
Funct.	Activation / Deactivation	Activ., Deactivated	Deactivated

## Solid fuel boiler

Solid fuel boiler	
Relay	R8
Sen. Boiler	S8
Sen. Store	S9

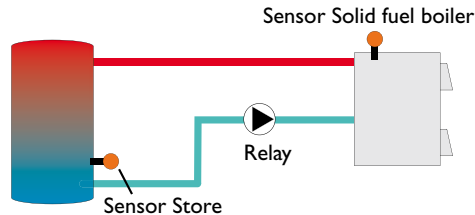

The solid fuel boiler function can be used for transferring heat from a solid fuel boiler to a store.

The allocated relay is energized when all switch-on conditions are fulfilled:

- the temperature difference between the allocated sensors has exceeded the switch-on temperature difference
- the temperature at the solid fuel boiler sensor has exceeded the minimum temperature
- the temperature at the store sensor has fallen below the maximum temperature

If  $\Delta T_{set}$  is exceeded, pump speed control will come into effect. For every deviation of 2 K [4 °Ra], the pump speed will be adjusted by 10 %.

### Arrangement / Opt. functions / Add new function.../ Solid fuel boiler

Adjustment channel	Description	Adjustment range / selection	Factory setting
Relay	Relay selection	system dependent	system dependent
Sen. Boiler	Solid fuel boiler sensor selection	system dependent	system dependent
Sen. Store	Store sensor selection	system dependent	system dependent
$\Delta T_{on}$	Switch-on temperature difference	1.0 ... 30.0 K [2.0 ... 60.0 °Ra]	6.0 K [12.0°Ra]
$\Delta T_{off}$	Switch-off temperature difference	0.5 ... 29.5 K [1.0 ... 59.0 °Ra]	4.0 K [8.0°Ra]
$\Delta T_{set}$	Set temperature difference	1.5 ... 40.0 K [3.0 ... 80.0 °Ra]	10.0 K [20.0°Ra]
Min. speed	Minimum speed	30 ... 100 %	30 %
Tmax St.	Maximum temperature	10 ... 95 °C [50 ... 204 °F]	60 °C [140 °F]
Tmin boiler	Minimum temperature	10 ... 95 °C [50 ... 204 °F]	60 °C [140 °F]
Funct.	Activation / Deactivation	Activ., Deactivated	Deactivated

## Circulation

Circulation	
▶ Relay	R9
Type	Thermal
Sensor	S10

The circulation function can be used for controlling a circulation pump.

For the control logic, 5 different variants are available:

- Thermal
- Timer
- Therm. + Timer
- Demand
- Demand + Timer

If one of the variants is selected, the corresponding adjustment channels will appear.

### Thermal

The temperature at the allocated sensor is monitored. The allocated relay switches on when the adjusted switch-on temperature is exceeded. If the temperature falls below the switch-off temperature, the relay switches off.

### Timer

The relay is switched on during the adjusted time frames, outside of them it switches off. For information on how to adjust the timer, see below.

### Therm. + Timer

The relay operates when the switch-on conditions of both above mentioned variants are fulfilled.

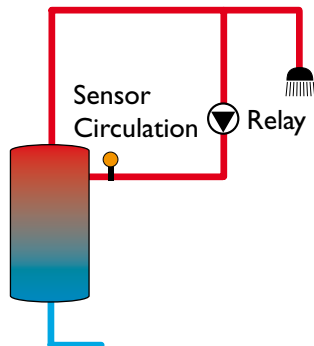

### Demand

The allocated FS08 flow switch is monitored for continuity (circuit continuity is achieved when fluid passes through the flow switch). If circuit continuity is detected at the flow switch, the relay switches on for the adjusted runtime. After the runtime has ended, the relay is switched off. During the adjusted break time, the relay remains switched off even if continuity is detected at the flow switch.



### Note:

If the flow switch is connected to the input S1...S12, continuity must be detected for at least 5 s for the controller to an impuls input at least 1 s.

## Demand + Timer

The relay operates when the switch-on conditions of both above mentioned variants are fulfilled.

Timer: Monday	
00:00	03:00 06:00 09:00
12:00	15:00 18:00 21:00

Days of the week	
▶	All days
<input type="checkbox"/>	Monday
<input type="checkbox"/>	Tuesday

When the **Timer**, **Therm. + Timer** or **Demand + Timer** variant is activated, a timer is indicated in which time frames for the function can be adjusted.

First of all, an overview of the current adjustment is displayed. For each day of the week there is an overview display. The display can be switched back and forth between the different days by pressing buttons  $\leftarrow 2$  or  $\leftarrow 4$ .

In order to adjust the timer, press button  $\leftarrow 5$ .

First, the individual days of the week or all days of the week can be selected. The last menu item after the list of days is **Continue**. If **Continue** is selected, the **Edit timer** menu opens, in which the time frames can be adjusted.

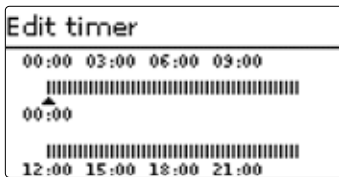

The time frames can be adjusted in steps of 15 minutes. The cursor can be moved along the time line by pressing buttons **2** or **4**.

The beginning of a time frame can be determined by pressing button **1**. The end of a time frame can be determined by pressing button **3**.

### Arrangement / Opt. functions / Add new function.../ Circulation

Adjustment channel	Description	Adjustment range / selection	Factory setting
Relay	Relay selection	system dependent	system dependent
Type	Circulation Type	Demand,Thermal,Timer, Therm.+Timer, Demand+Timer	Thermal
Sensor	Circulation sensor selection	system dependent	system dependent
Ton	Switch-on temperature	10 ... 59 °C [50 ... 138 °F]	40 °C [104 °F]
Toff	Switch-off temperature	11 ... 60 °C [52 ... 140 °F]	45 °C [114 °F]
Timer	Timer	-	-
Days of the week	Day selection	All days, Monday ... Sunday, Continue	-
Timer	Time frame adjustment	00:00 ... 23:45	-
Sensor	FS08 sensor input selection	system dependent	system dependent
Delay	Demand delay time	0...2s	1 s
Runtime	Runtime	01:00 ... 15:00 min	03:00 min
Break time	Break time	10 ... 60 min	30 min
Funct.	Activation / Deactivation	Activ., Deactivated	Deactivated

## Return preheating

Ret. preheat.	
► Relay	R8
Sen. Return	S7
Sen. HS	S8

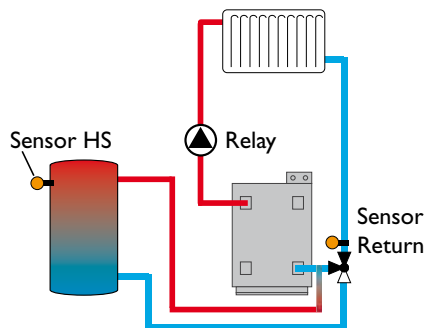

The return preheating function can be used for transferring heat from a heat source to the heating circuit return.

The allocated relay is energized when both switch-on conditions are fulfilled:

- the temperature difference between the allocated sensors has exceeded the switch-on temperature difference
- the temperature at the outdoor temperature sensor has fallen below the adjusted outdoor temperature

With the summer switch-off option, the return preheating can be suppressed outside the heating period. If the heating circuit concerned is controlled by the controller, the adjustments automatically adapt to the heating circuit.

### Arrangement / Opt. functions / Add new function.../ Ret. preheat.

Adjustment channel	Description	Adjustment range / selection	Factory setting
Relay	Relay selection	system dependent	system dependent
Sen. Return	Return sensor selection	system dependent	system dependent
Sen. HS	Heat source sensor selection	system dependent	system dependent
$\Delta$ Ton	Switch-on temperature difference	2.0 ... 30.0 K [4.0 ... 60.0 °Ra]	6.0 K [12.0 °Ra]
$\Delta$ Toff	Switch-off temperature difference	1.0 ... 29.0 K [2.0 ... 58.0 °Ra]	4.0 K [8.0 °Ra]
Summer off	Summer switch-off option	Yes, No	No
Sensor	Outdoor sensor selection	system dependent	system dependent*
Toff	Switch-off temperature	10 ... 60 °C [50 ... 140 °F]	20 °C [68 °F]
Funct.	Activation / Deactivation	Activ., Deactivated	Deactivated

\*When a heating circuit has been activated, this adjustment is determined by the corresponding parameter in the heating circuit menu.



## Function block

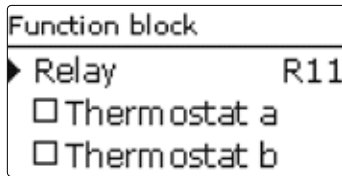

In addition to the pre-defined optional functions, function blocks consisting of thermostat functions, timer and differential functions are available. With the help of these function blocks, further components, resp. functions can be controlled.

To each function block, sensors and free relays can be allocated. Sensors already in use can be allocated again without impeding their control functions.

Within a function block the functions are intercon-

Function	Function block 1
Relay	3
Thermostat	thermostat a- S3
	thermostat b- S4
Differential function $\Delta T$	Sen. 1
	Sen. 2
Timer	Timer

nected (AND gate). This means that the conditions of all the activated functions have to be fulfilled (e. g. thermostat and timer) for switching the allocated relay. As soon as one condition is not fulfilled, the relay is switched off.

### Thermostat function

The relay allocated to the function block is switched on, when the adjusted switch-on temperature (**Th(x)on**) is reached. It is switched off when the adjusted switch-off temperature (**Th(x)off**) is reached. The switching conditions of all other activated functions of the function block have to be fulfilled as well.

Allocate the reference sensor in the expert menu.

Adjust the maximum temperature limitation with

**Th(x)off** > **Th(x)on** and the minimum temperature limitation with **Th(x)on** > **Th(x)off**. The temperatures cannot be set to an identical value.

### $\Delta T$ -function

The relay allocated to the function block is switched on as soon as the adjusted switch-on temperature difference ( $\Delta\text{Th(x)on}$ ) is reached. It is switched off as soon as the adjusted switch-off temperature difference ( $\Delta\text{Th(x)off}$ ) is reached. The switching conditions of all other activated functions of the function block have to be fulfilled as well.

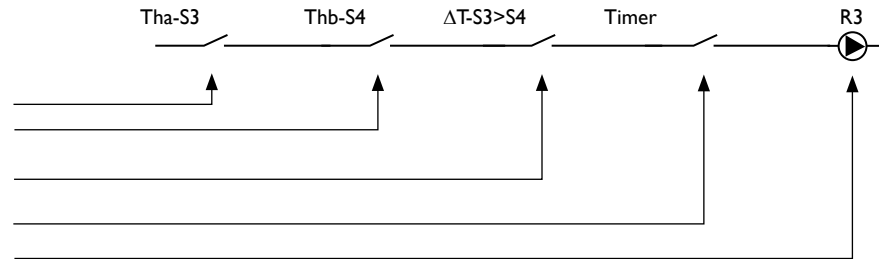

## Arrangement / Opt. functions / Add new function.../ Function block

Adjustment channel	Description	Adjustment range / selection	Factory setting
Relay	Relay	R2	R2 ... R14
Thermostat a	Thermostat a	Yes, No	No
Th-a on	Switch-on temperature Thermostat a	-40 ... 250 °C [-40 ... 482 °F]	40 °C [104 °F]
Th-a off	Switch-off temperature Thermostat a	-40 ... 250 °C [-40 ... 482 °F]	45 °C [114 °F]
Sensor	Sensor thermostat a	S1 ... S12	S4
Thermostat b	Thermostat b	Yes, No	No
Th-b on	Switch-on temperature Thermostat b	-40 ... 250 °C [-40 ... 482 °F]	40 °C [104 °F]
Th-b off	Switch-off temperature Thermostat b	-40 ... 250 °C [-40 ... 482 °F]	45 °C [114 °F]
Sensor	Sensor thermostat b	S1 ... S12	S5
ΔT function	Differential function	Yes, No	No
ΔTon	Switch-on temperature difference	1.0 ... 50.0 K [2.0 ... 100.0 °Ra]	5.0 K [10.0 °Ra]
ΔToff	Switch-off temperature difference	0.5 ... 49.5 K [1.0 ... 99.0 °Ra]	3.0 K [6.0 °Ra]
Sen. So.	Heat source sensor	Controller S1 ... S12	S6
Sen. Sink	Heat sink sensor	Controller S1 ... S12	S7
Timer	Timer	-	-
Days of the week	Day selection	All days, Monday ... Sunday, Continue	-
Timer	Time frame adjustment	00:00 ... 23:45	-
Funct.	Activation/Deactivation	Activ./Deactivated	Deactivated

## Irradiation switch

Irrad. switch	
► Relay	R11
Irrad.	200 W/m <sup>2</sup>
Duration	2 min

## Arrangement / Opt. functions / Add new function.../ Irradiation switch

Adjustment channel	Description	Adjustment range / selection	Factory setting
Relay	Relay selection	system dependent	system dependent
Irrad.	Switch-on irradiation	50 ... 1000 W/m <sup>2</sup>	200 W/m <sup>2</sup>
Duration	Switch-on duration	0 ... 30 min	2 min
Inverted	Inverted switching option	Yes, No	No
Funct.	Activation / Deactivation	Activ., Deactivated	Deactivated

The **Irrad. switch** function can be used for operating a relay depending on the measured irradiation value.

The allocated relay is switched on if the adjusted irradiation value remains exceeded for the adjusted duration. If the irradiation falls below the adjusted value for the adjusted duration, the relay is switched off.

If the **Inverted** option is activated, the relay operates vice versa.

## 10 Heating

Heating	
► Demands	
HCs	
Opt. functions	

In this menu, all adjustments for the heating part of the arrangement or for the heating circuits respectively can be made.

Demands can be activated, heating circuits can be parameterized and optional functions can be selected and adjusted.

## 10.1 Demands

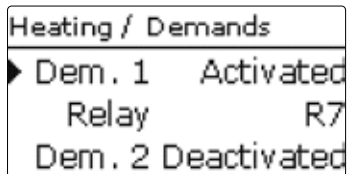

### Heating / Demands

Adjustment channel	Description	Adjustment range / selection	Factory setting
Demand 1 (2)	Demand 1 (2)	Activ., Deactivated	Deactivated
Relay	Relay selection	system dependent	system dependent

## 10.2 Heating circuits

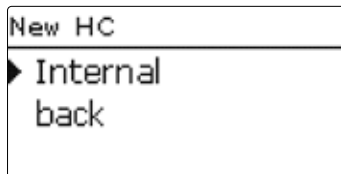

The controller has two internal, weather-compensated heating circuits and is able to control up to 5 external heating circuits by means of extension modules.

In the menu appearing when **New heating circuit** is selected, it is possible to choose between the internal heating circuits and, if available, registered modules.

If one or more extension modules are connected, they have to be registered with the controller. Only registered modules are available in the heating circuit selection.

Extension modules can be registered in the **In-/Outputs / Modules** menu (see page 72).

If an internal or external heating circuit has been selected, a new menu opens. In this menu, all sensors and relays required for the heating circuit can be allocated, and all adjustments can be made.

The controller calculates the set flow temperature for each heating circuit by means of the outdoor temperature and the selected heating curve. If the measured flow temperature deviates from the set flow temperature, the mixer is activated in order to adjust the flow temperature correspondingly.

If the outdoor temperature falls below the point where the calculated set flow temperature would exceed the maximum flow temperature, the maximum flow temperature is treated as the set temperature for as long as the condition remains.

If the outdoor temperature sensor is defective, an error message is indicated. For the duration of this condition, the maximum flow temperature -5 K is assumed as set flow temperature.

With the timer, the day / night operation can be ad-

In this menu, up to 2 heating demands can be activated and adjusted.

**Activated demands will be available for selection in the relay allocation channels of the corresponding optional functions. This way, several optional functions can demand the same heat source.**

If, for example the potential-free changeover relay R14 is allocated to **Demand 1**, the selection **AH-Dem.1** will then become available in addition to the free relays in the adjustment channels **Demand** of the optional functions for the heating part of the arrangement (see page 64). This way, e. g. the DHW heating function can demand the same boiler for back-up heating as the thermal disinfection function.

justed. During day phases, the set flow temperature is increased by the adjusted day correction value, during night phases it is decreased by the night correction value (night setback).

Summer mode

The **Mode** channel adjustment determines how the heating circuit is set to summer mode:

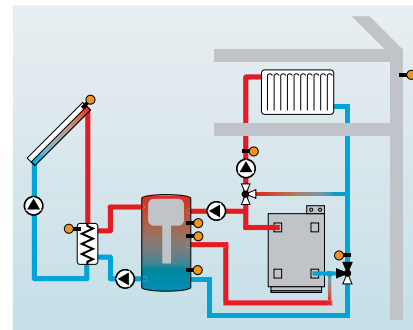

**Summer off:** The summer mode becomes active when the outdoor temperature exceeds the adjusted summer temperature **TSummer**.

**Ext. switch:** A switch is connected to a selected sensor input. If the switch is operated, the heating circuit is set to summer mode regardless of the outdoor temperature.

**Both:** Summer mode is activated regardless of the outdoor temperature when the switch is operated. As long as the switch is not operated, summer mode control works as described for **Summer off**.

Summer temperature

If **Summer off** or **Both** has been selected in the **Mode** channel, the summer temperature **TSummer** can be adjusted. If the outdoor temperature exceeds the value adjusted in **TSummer**, the heating circuit pump is switched off.

For the summer temperature, a daytime time frame can be adjusted with the channels **Daytime** on and **Daytime** off. Outside this time frame, the adjustable temperature **TNight** replaces **TSummer**.

With the **Room thermostat** option, up to 5 room thermostats can be integrated into the control logic.

heating curves

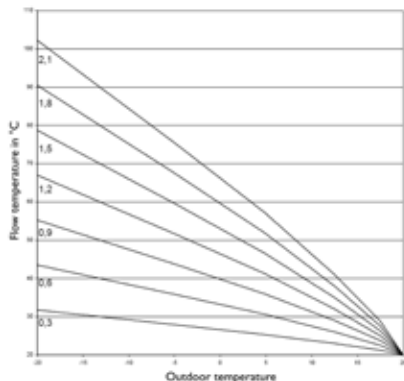

To each room thermostat, a sensor input can be allocated. The temperature at the allocated sensor is monitored. If the measured temperature exceeds the adjusted **Room temperature** value at all activated room thermostats, the heating circuit pump is deactivated and the mixer remains in its current position. If the **Timer RTH** option is activated, time frames can be set for the room thermostats (for information on how to adjust the timer see below). During these time frames, the adjusted room temperature is decreased by the **Correction** value.

To each room thermostat, an additional relay can be allocated. That relay will operate when the temperature at the allocated sensor falls below the adjusted room temperature. This way, the room in question can be excluded from the heating circuit via a valve as long as the desired room temperature is reached.

In the channel **RTH**, the room thermostat can be temporarily deactivated or re-activated respectively. All adjustments remain stored.

When the **Timer** option is activated, a timer is indicated in which time frames for the function can be adjusted.

First of all, an overview of the current adjustment is displayed. For each day of the week there is an overview display. The display can be switched back and forth between the different days by pressing buttons **2** or **4**.

In order to adjust the timer, press button **5**.

First the individual days of the week or all days of the week can be selected. The last menu item after the list of days is **Continue**. If **Continue** is selected, the **Edit timer** menu opens, in which the time frames can be adjusted.

The time frames can be adjusted in steps of 15 minutes. The cursor can be moved along the time line by pressing buttons **2** or **4**. The beginning of a time

frame can be determined by pressing button **1**. The end of a time frame can be determined by pressing button **3**.

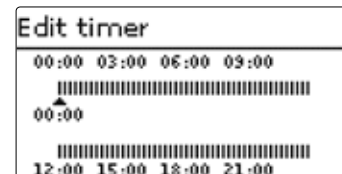
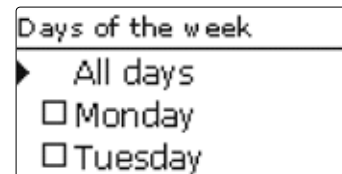
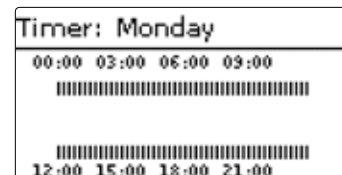

## Heating / HCs / New HC / Internal

Adjustment channel	Description	Adjustment range / selection	Factory setting
HC pump	Heating circuit pump	system dependent	system dependent
Mixer open	Relay selection mixer open	system dependent	system dependent
Mixer closed	Relay selection mixer closed	system dependent	system dependent
Flow sensor	Flow sensor selection	system dependent	system dependent
Sen. outd.	Outdoor sensor selection	system dependent	system dependent
Heating curve	Heating curve	0.3 ... 3.0	1.0
Day correction	Day correction	-5 ... +45 K [-10 ... +90 °Ra]	0 K [0 °Ra]
Tflowmax	Maximum flow temperature	10 ... 100 °C [50 ... 212 °F]	50 °C [122 °F]
Mode	Operation mode	Summer off, Ext. switch, both	Summer off
TSummer	Summer temperature day	0 ... 40 °C [32 ... 104 °F]	20 °C [68 °F]
Daytime on	Daytime on	00:00 ... 23:45	00:00
Daytime off	Daytime off	00:00 ... 23:45	00:00
TSummer	Summer temperature night	0 ... 40 °C [32 ... 104 °F]	14 °C [58 °F]
Ext.switch	External switch sensor input selection	system dependent	system dependent
Remote control	Remote control option	Yes, No	No
Sen. Rem.control	Remote control sensor input selection	system dependent	system dependent
Timer	Timer option	Yes, No	No
Mode	Timer mode	Day / Night, Day / Off	Day / Night
Night corr.	Night correction	-20 ... +30 K [-40 ... +60 °Ra]	-5 K [-10 °Ra]
Timer	Timer	-	-
Days of the week	Day selection	All days, Monday ... Sunday, Continue	-
Timer	Time frame adjustment	00:00 ... 23:45	-
Room therm. 1 ... 5	Room thermostat option (1 ...5)	Yes, No	No
RTH sen.	RTH sensor input selection	system dependent	system dependent
TRoom.	Room temperature	10 ... 30 °C [50 ... 86 °F]	18 °C [64 °F]
Timer	RTH timer	Yes, No, Inactive	No
Days of the week	Day selection	All days, Monday ... Sunday, Continue	-

Adjustment channel	Description	Adjustment range / selection	Factory setting
Timer	Time frame adjustment	00:00 ... 23:45	-
Correction	Correction	1 ... 20 K [2 ... 40 °Ra]	5 K [10 °Ra]
Relay	RTH relay selection	system dependent	system dependent
RTH	Room thermostat	Activ., Deactivated	Deactivated
Afterheating	Afterheating option	Yes, No	No
Mode	Afterheating mode	Therm., Boiler	Therm.
Relay	Afterheating relay selection	system dependent	system dependent
Sensor 1	Afterheating sensor 1 selection	system dependent	system dependent
Sensor 2	Afterheating sensor 2 selection	system dependent	system dependent
Loading pump	Loading pump option	Yes, No	No
Relay	Loading pump relay selection	system dependent	system dependent
Overrun time	Loading pump overrun time	0 ... 300 s	60 s
Acti...	Activation / Deactivation	Activ., Deactivated	Deactivated
ΔTon	Switch-on temperature difference	-15.0...+44.5 K [-30.0...+89.0 °Ra]	5.0 K [10.0 °Ra]
ΔToff	Switch-off temperature difference	-14.5...+45.0 K [-29.0...+90.0 °Ra]	15.0 K [30.0 °Ra]
Function	Function activated / deactivated	Activ., Deactivated	Deactivated
Interval	Mixer interval	1 ... 20 s	4 s
Runtime	Mixer runtime	10 ... 600 s	240 s
Offset	Automatic adaption of the mixer runtime	-	-
Time	Adjustment time	00:00 ... 23:45	23:30
Chimney sweeper	Chimney sweeper function	Yes, No	No
Frost protection	Antifreeze option	Yes, No	Yes
Sensor	Antifreeze option sensor	Flow, Outdoor	Flow
Antifreeze	Antifreeze temperature	-20 ... +10 °C [-4 ... +50 °F]	+4 °C [+40 °F]
Runtime	Antifreeze runtime	15 ... 240 s	30 s
DHW priority	DHW priority option	Yes, No	No
Funct.	Activation / Deactivation	Activ., Deactivated	Deactivated

## Chimney sweeper function

The chimney sweeper function can be used for enabling a quick access to measurement conditions without menu operation for the chimney sweeper.

If the chimney sweeper function is activated, the chimney sweeper mode can be accessed by pressing button **6** for 5 seconds.

In the chimney sweeper mode, the heating circuit mixer closes, the loading pump and the backup heating contact are activated. While the chimney sweeper mode is active, the directional pad is illuminated. Additionally, **Chimney sweeper** and a countdown of 30 minutes are indicated on the display.

When the countdown has elapsed, the chimney sweeper mode is automatically deactivated. If, during the countdown, button **6** is again pressed for more than 10 seconds, the countdown starts again.

In order to abort the countdown and thus deactivate the chimney sweeper mode, briefly press button **6**.

### 10.3 Optional functions

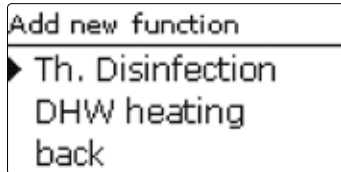

In this menu, additional functions can be selected and adjusted for the heating part of the arrangement.

By selecting **Add new function...**, different pre-programmed functions can be selected. The optional functions are available as long as free relays are available.

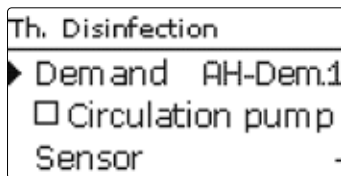

When a function is selected, a submenu opens in which all adjustments required can be made.

With this submenu, a relay and, if necessary, certain system components can be allocated to the function.

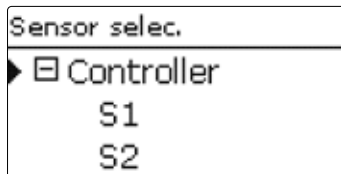

The menu item **Demand** is available in all optional heating functions. Therefore, it will not be explained in the individual function descriptions.

With this menu item, an backup heating demand relay can be allocated to the function. All free relays are available for selection.

In the submenu **Controller**, all free relays of the controller are displayed. If external modules are connected and registered, their relays will be displayed in corresponding submenus.

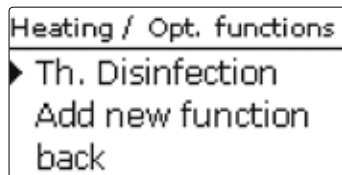

When a function has been selected and adjusted, it will appear in the **Opt. functions** above the menu item **Add new function...**

This allows an easy overview of functions already activated.

An overview about which sensor has been allocated to which component and which relay has been allocated to which function is given in the **Status/Service** menu.

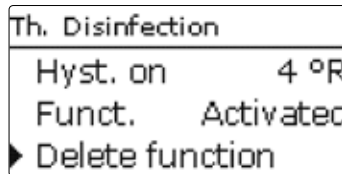

At the end of each optional function submenu, the menu items **Function** and **Delete function** are available.

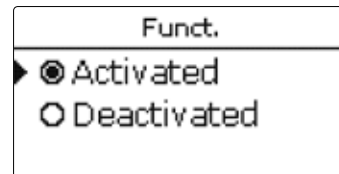

With the menu item **Function**, an optional function already selected can be temporarily deactivated or re-activated respectively. All adjustments remain stored, the allocated relays remain occupied and cannot be allocated to another function.

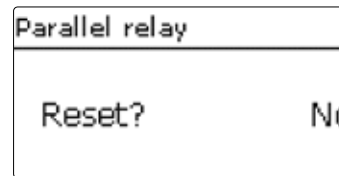

If the menu item **Delete function** is confirmed by pressing button **5**, a security enquiry appears. The setting can be changed between **Yes** and **No** by pressing buttons **2** and **4**. If **Yes** has been selected and confirmed by pressing button **5**, the function is deleted and available under **Add new function...** again. The corresponding relays are available again.



## Thermal disinfection

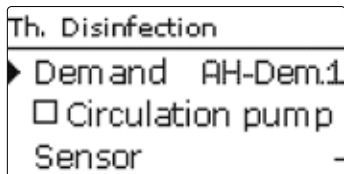

This function helps to contain the spread of Legionella in DHW stores by systematically activating the backup heating.

For thermal disinfection, the temperature at the allocated sensor has to be monitored. This protection is ensured when, during the monitoring period, the disinfection temperature is continuously exceeded for the entire disinfection period.

If the thermal disinfection function is activated, the monitoring period starts as soon as the temperature at the allocated sensor falls below the disinfection temperature. When the monitoring period ends, the allocated reference relay activates the backup heating. The disinfection period starts to count as soon as the temperature at the allocated sensor exceeds the disinfection temperature.

If the temperature at the allocated sensor exceeds the disinfection temperature by more than 5 K [10 °Ra], the reference relay switches off until the temperature has fallen below a value of 2 K [4 °Ra], above the disinfection temperature.

Thermal disinfection can only be completed when the disinfection temperature is exceeded for the duration of the disinfection period without interruption.

If the disinfection conditions have been fulfilled by solar loading before the monitoring period ends, thermal disinfection is considered complete and a new monitoring period begins.

Due to the flexible control logic, the exact time of thermal disinfection is not predictable. In order to set a fixed time for the disinfection to be run, the starting delay must be used:

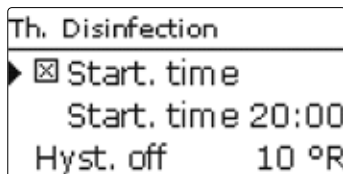

If the starting delay option **Starting time** is activated, a starting time for the thermal disinfection with starting delay can be adjusted. The activation of the backup heating is then delayed until that starting time after the monitoring period has ended.

If the monitoring period ends, for example, at 12:00 o'clock, and the starting time has been set to 18:00, the reference relay will be energized with a delay of 6 hours at 18:00 instead of 12:00 o'clock.

If, during the waiting time, the disinfection conditions are fulfilled by solar loading, thermal disinfection is considered complete and a new monitoring period begins.

### Heating / Opt. functions / Add new function.../Th. disinfection

Adjustment channel	Description	Adjustment range / selection	Factory setting
Demand	Demand relay selection	system dependent	system dependent
Circulation pump	Circulation pump option	Yes, No	No
Relay	Circulation pump relay selection	system dependent	system dependent
Sensor	Disinfection sensor selection	system dependent	system dependent
Monit.	Monitoring period	0 ... 30:1 ... 23 (dd:hh)	01:00 (1 day)
Temperature	Disinfection temperature	45 ... 90 °C [114 ... 194 °F]	60 °C [140 °F]
Duration	Disinfection period	0.5 ... 24.0 h	1 h
Start. time	Starting delay option	Yes, No	No
Start. time	Starting point	00:00 ... 23:30	20:00
Function	Activation / Deactivation	Activ., Deactivated	Deactivated

## DHW heating

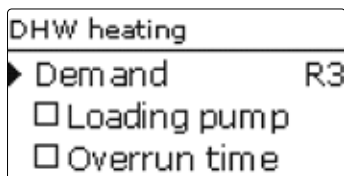

The DHW heating is used to demand a backup heating for heating the DHW store.

If the **Loading pump** option is activated, another adjustment channel appears, in which a relay can be allocated to the loading pump. The allocated relay is switched on and off with the demand relay.

If the **Overrun time** option is activated, another adjustment channel appears, in which the overrun time can be adjusted. If the overrun time option is activated, the loading pump relay remains switched on for the adjusted **Duration** after the demand relay has been switched off.

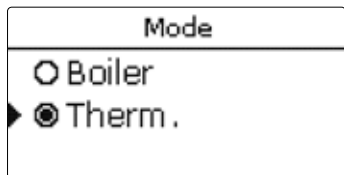

For the DHW heating, different modes are available:

### Thermal mode:

The allocated demand relay is switched on when the temperature at the allocated sensor 1 falls below the adjusted switch-on temperature. If the temperature at the allocated sensor 1 exceeds the adjusted switch-off temperature, the relay is switched off.

### Boiler mode:

If the Boiler mode has been selected, another sensor can be allocated in the channel Sensor 2. The switch-on, or the switch-off conditions respectively, then have to be fulfilled at both sensors in order for the relay to be energized.

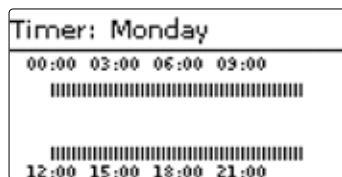

When the **Timer** option is activated, a timer is indicated in which time frames for the function can be adjusted.

First of all, an overview of the current adjustment is displayed. For each day of the week there is an overview display. The display can be switched back and forth between the different days by pressing buttons **2** or **4**.

In order to adjust the timer, press button **5**.

First the individual days of the week or all days of the week can be selected. The last menu item after the list of days is **Continue**. If **Continue** is selected, the **Edit timer** menu opens, in which the time frames can be adjusted.

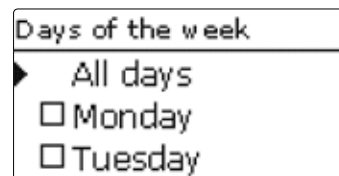

The time frames can be adjusted in steps of 15 minutes. The cursor can be moved along the time line by pressing buttons **2** or **4**. The beginning of a time frame can be determined by pressing button **1**. The end of a time frame can be determined by pressing button **3**.

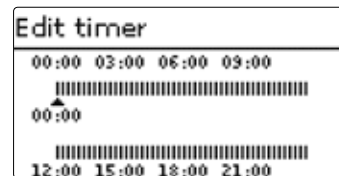

## Heating / Opt. functions / Add new function.../ DHW heating

adjustment channel	Description	Adjustment range / selection	Factory setting
Demand	Demand relay selection	system dependent	system dependent
Loading pump	Loading pump option	Yes, No	No
Relay	Loading pump relay selection	system dependent	system dependent
Overrun time	Overrun option	Yes, No	No
Duration	Overrun time	1 ... 10 min	1 min
Mode	Operating mode	Boiler, Therm.	Therm.
Sensor 1	Sensor 1	system dependent	system dependent
Sensor 2	Sensor 2 (only if Mode = Boiler)	system dependent	system dependent
Ton	Switch-on temperature	0 ... 94 °C [32 ... 202 °F]	40 °C [104 °F]
Toff	Switch-off temperature	1 ... 95 °C [34 ... 204 °F]	45 °C [114 °F]
Timer	Timer option	Yes, No	No
Timer	Timer	-	-
Days of the week	Day selection	All days, Monday ... Sunday, Continue	-
Timer	Time frame adjustment	00:00 ... 23:45	-
Funct.	Activation / Deactivation	Activ., Deactivated	Deactivated

## 11 HQM

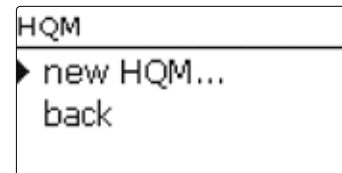

In the **HQM** menu, up to seven internal heat quantity measurements can be activated and adjusted.

By selecting the menu item **New HQM**, a new heat quantity measurement can be activated.

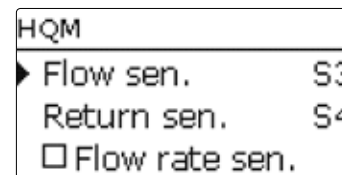

A menu opens in which all adjustments required for the heat quantity measurement can be made.

If the **Flow rate sensor** option is activated, the impulse input or, if available, a Grundfos Direct Sensor™ can be selected. Grundfos Direct Sensors™ are only available if they have been previously registered in the In-/Outputs menu. The impulse rate must be adjusted in that menu as well.

If the **Flow rate sensor** option is deactivated, the controller calculates the heat quantity by means of a fixed flow rate value. This is called heat quantity balancing. For this purpose, the flow rate must be read from the flowmeter at 100 % pump speed and adjusted in the adjustment channel **Flow rate**. In addition to that, a **Relay** must be allocated. Heat quantity balancing is in effect whenever the allocated relay is active.

In the adjustment channel **Fluid type**, the heat transfer fluid must be selected. If either Propylene glycol

or Ethylene glycol is selected, the adjustment channel **Ratio** is indicated in which the antifreeze ratio of the heat transfer fluid can be adjusted.

When the **Alternative unit** is activated, the controller will convert the heat quantity into the quantity of fossil fuels (coal, oil or gas) saved, or the CO<sub>2</sub> emission saved respectively. The alternative **Unit** can be selected. A conversion **Factor** must be adjusted for the calculation. The conversion factor depends on the arrangement in use and has to be determined individually.

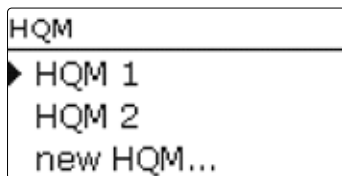

Heat quantity measurements already activated will appear in the **HQM** menu above the menu item **New HQM** in numerical order.

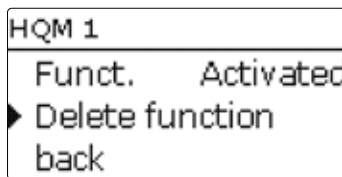

If an activated heat quantity measurement is selected, the above mentioned menu with all adjustment values will re-open.

To deactivate a heat quantity measurement, select the menu item **Delete function** at the bottom of the menu.

The heat quantity measurement deleted will disappear from the list and become available for selection in the **New HQM** menu again. The numeration of the other activated heat quantity measurements will not change.

### HQM / New HQM

Adjustment channel	Description	Adjustment range / selection	Factory setting
Flow sen.	Flow sensor selection	system dependent	system dependent
Return sen.	Return sensor selection	system dependent	system dependent
Flow rate sen.	Flow rate sensor option	Yes, No	No
Flow rate sen.	Flow rate sensor selection	Imp1 ... Imp3, Ga1, Ga2, Gd1, Gd2	-
Flow rate	Flow rate (only if Flow rate sen.= No)	1.0 ... 500.0 l/min	3.0 l/min
Relay	Relay selection	system dependent	system dependent
Fluid type	Heat transfer fluid	Tyfocor LS, Propyl., Ethyl., Water	Water
Ratio	Glycol ratio in the heat transfer fluid (only if Fluid type = Propylene glycol or Ethylene glycol)	5 ... 100 %	40 %
Alternative unit	Alternative unit option	Yes, No	No
Unit	Alternative display unit	Coal, Gas, Oil, CO <sub>2</sub>	CO <sub>2</sub>
Factor	Conversion factor	0.01 ... 100.00	0.50
Funct.	Activation / Deactivation	Activ., Deactivated	Deactivated

## 12 Basic settings

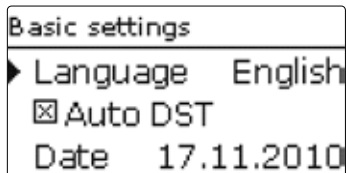

In the **Basic settings** menu, all basic parameters for the controller can be adjusted. Normally, these settings have been made during commissioning. They can be subsequently changed in this menu.

### Basic settings

Adjustment channel	Description	Adjustment range / selection	Factory setting
Language	Selection of the menu language	Deutsch, English, Francais	Deutsch
Auto DST	Daylight savings time selection	Yes, No	Yes
Date	Adjustment of the current date	01.01.2001 ... 31.12.2099	01.01.2010
Time	Adjustment of the current time	00:00 ... 23:59	-
Temp. Unit	Temperature unit	°C, °F	°C
Vol. unit	Unit of volume	Gallons, Litre	Litre
Press. unit	Unit of pressure	psi, bar	bar
Energy unit	Energy unit	Wh, BTU	Wh
Factory setting	back to factory settings	Yes, No	No

## 13 SD card

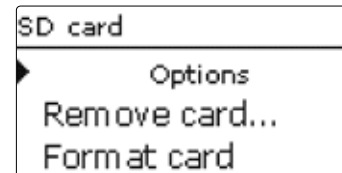

The controller is equipped with an SD card slot for SD memory cards.

The following functions can be carried out with an SD card:

- Logging measurement and balance values. The values can be opened and visualized on a computer, e.g. in a spreadsheet programme.
- Transferring adjustments and parameterizations prepared on the computer onto the controller.
- Storing adjustments and parameterizations onto the SD card and restoring them if necessary.
- Run firmware updates onto the controller.

### Firmware updates

When an SD card with a firmware update is inserted, the enquiry **Update?** is indicated on the display. The setting can be changed between **Yes** and **No** by pressing buttons **2** and **4**.

➔ To run the update, select **Yes** and confirm by pressing button **5**.

The update is run automatically. The indication **Please wait** and a progress bar appear on the display. When the update has been completed, the controller will automatically reboot and run a short initialization phase.

➔ To skip the update, select **No**.

The controller commences normal operation.

**Note:**

The controller will only find a firmware update on an SD memory card when it is stored on the first level of the SD card.

**Starting the logging**

- Insert the SD card into the slot
- Adjust the desired logging type and interval

Logging will start immediately.

**Stop the logging**

- Select the menu item **Remove card...**
- After **Remove card** is displayed, remove the card from the slot

When **Linear** is adjusted in the adjustment channel **Logging type**, data logging will stop if the capacity limit is reached. The message **Card full** will be displayed.

If **Cyclic** is adjusted, the oldest data logged onto the SD card will be overwritten as soon as the capacity limit is reached.

**Note:**

Because of the increasing size of the data packets, the remaining logging time does not decrease linearly. The data packet size can increase, e. g. with the increasing operating hours value.

**Storing controller adjustments**

- To store the controller adjustments on an SD card, select the menu item **Save adjustments**.

While the adjustments are being stored, first **Please wait**, then **Done!** will be indicated on the display. The controller adjustments are stored as a .SET file on the SD card.

**Loading controller adjustments**

- To load controller adjustments from an SD card, select the menu item **Load adjustments**.

The File selection window is indicated.

- Select the desired .SET file.

While the adjustments are being loaded, first **Please wait**, then **Done!** will be indicated on the display.

**Formatting the SD card**

- Select the menu item **Format card**

The content of the card will be deleted and the card will be formatted with the FAT file system.

**Note:**

To safely remove the SD card, always select the menu item **Remove card...** before removing the card.

**SD card**

Adjustment channel	Description	Adjustment range / selection	Factory setting
Remove card...	Safely remove card	-	-
Save adjustments	Save adjustments	-	-
Load adjustments	Load adjustments	-	-
Logging interval	Logging interval	00:01 ... 20:00 (mm:ss)	01:00
Logging type	Logging type	Cyclic, Linear	Linear
Format card	Format card	-	-

## 14 Manual mode

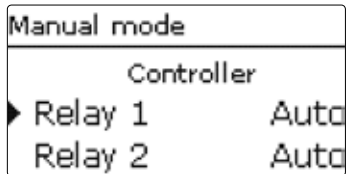

In the **Manual mode** menu, the operating mode of all relays in the controller and in connected modules can be adjusted.

All relays are displayed in numerical order, first those of the controller, then those of the individual modules connected. Modules are listed in numerical order.

Under the menu item **All relays...**, all relays can be switched off (Off) or set to automatic mode (Auto) at once.

Off = Relay is switched off (manual mode)

Auto = Relay is in automatic mode

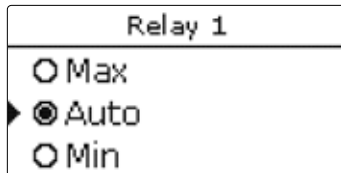

The operating mode can be selected for each individual relay, too. The following options are available:

Off = Relay is switched off (manual mode)

Min. = Relay active with minimum speed (manual mode)

Max. = Relay active at 100 % speed (manual mode)

Auto = Relay is in automatic mode



### Note:

Always adjust the operating mode back to **Auto** when the control and service work is completed. Otherwise normal operation will not be possible.

### Manual mode

Adjustment channel	Description	Adjustment range / selection	Factory setting
Relays R1 ... X	Operating mode selection	Max, Auto, Min, Off	Auto
All relays...	Operating mode selection for all relays	Auto, Off	Off

## 15 User code

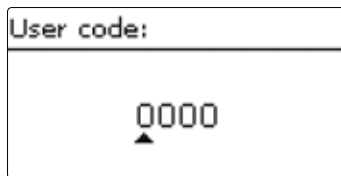

In the **User code** menu, a user code can be entered. Each number of the 4-digit code must be individually adjusted and confirmed. After the last digit has been confirmed, the menu automatically jumps to the superior menu level.

To access the menu areas of the expert level, the expert user code must be entered:

Expert user code: 0262

For safety reasons, the user code should generally be set to the customer code before the controller is handed to the customer!

Customer user code: 0000

## 16 In- / Outputs

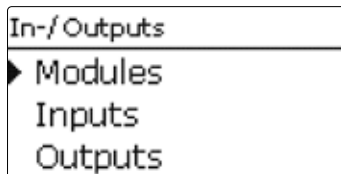

In the **In- / Outputs** menu, external modules can be registered, sensor offsets can be adjusted and relay outputs can be configured.

### 16.1 Modules

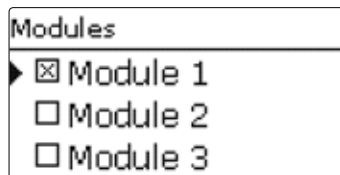

In this menu, up to 5 external modules can be registered.

All modules connected and acknowledged by the controller are available.

→ To register a module, select the corresponding menu item by pressing button **5**

The checkbox indicates the selection. If a module is registered, all its sensor inputs and relay outputs will be available in the corresponding controller menus.

#### In- / Outputs / Modules

Adjustment channel	Description	Adjustment range / selection	Factory setting
Module 1 ... 5	Registering external modules	-	-



## 16.2 Inputs

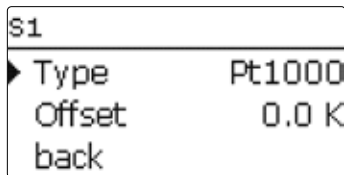

In this submenu, the type of the sensor connected can be adjusted for each individual input. The following types can be selected:

- Switch
- KTY
- Pt500
- RTA11M
- Pt1000
- None

### ATTENTION! System damage!



Selecting the wrong sensor type will lead to unwanted controller actions. In the worst case, system damage can occur!

➔ **Make sure that the right sensor type is selected for each input!**

If KTY, Pt500 or Pt1000 are selected, the channel **Offset** appears, in which an individual offset can be adjusted for each sensor.

➔ In order to adjust the offset, select the corresponding menu item by pressing button ⑤

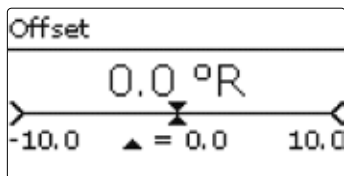

## In- / Outputs / Inputs

Adjustment channel	Description	Adjustment range / selection	Factory setting
S1 ... S12	Sensor input selection	-	-
Type	Sensor type selection	Switch, KTY, Pt500, RTA11M, Pt1000, None	Pt1000
Offset	Sensor offset	-5.0...+5.0 K [-10.0...+10.0 °Ra]	0.0 K [0.0 °Ra]
Imp. 1 ... 3	Sensor type selection Imp 1...3	Impulse, Switch, KTY, Pt500, RTA11M, Pt1000, None	Impulse
Vol./Imp.	Impulse input selection	-	-
Type	Sensor type selection	Impulse, Switch, KTY, Pt500, RTA11M, Pt1000, None	Impulse
CS10	CS10 input	-	-
Type	CS type	A ... K	E
Offset	Delete offset	Yes, No	No
Ga1, 2	Analog Grundfos Direct Sensor™	-	-
Type	Grundfos Direct Sensor™ type	RPS, VFS, None	None
Gd 1,2	Digital Direct Sensor™ type	-	-
Type	Grundfos Direct Sensor™ type	RPD, VFD, None	None
Min.	Minimum pressure (if Type = RPS)	0.0 ... 0.5 bar	0.0 bar
Max.	Maximum pressure (if Type = RPS)	0.1 ... 16.0 bar	0.6 bar
Min.	Minimum flow rate (if Type = VFS)	1 ... 39 l/min	2 l/min
Max.	Maximum flow rate (if Type = VFS)	2 ... 400 l/min	40 l/min

➔ To adjust the sensor offset, select the desired value by pressing buttons ② or ④, then confirm by pressing button ⑤

➔ Confirm the reset enquiry with **Yes**  
➔ Select **back** to return to the **Inputs** menu, then connect the CS sensor

### CS sensor offset

If a CS10 irradiation sensor is to be connected, an offset has to be carried out before the connection is made.

To carry out the offset, proceed as follows:

- ➔ Adjust the CS type in the **Type** channel
- ➔ Select the **Offset** channel



### Note:

If Grundfos Direct Sensors™ are used, connect the sensor grounding common terminal block with the protective grounding conductor (see chap. 2.2).

## 16.3 Outputs

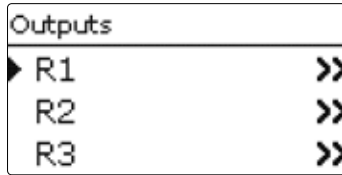

In this menu, the signal type and the minimum speed can be adjusted for each individual relay of the controller and the external modules.

➔ In order to make adjustments for a relay, select the corresponding menu item by pressing button (5).

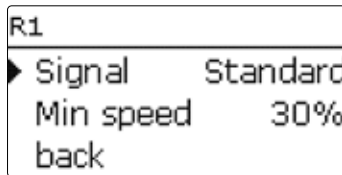

For each relay, the signal type and the minimum pump speed can be adjusted.

The signal type determines the way speed control of a connected pump is effected. The following modes are available:

Adapter = speed control signal via a VBus®/PWM interface adapter

0-10 V = speed control via a 0-10 V signal

PWM = speed control via a PWM signal

Standard = pulse packet speed control (factory setting)

With the signal types Adapter, 0-10 V and PWM, the relay itself is not involved in speed control. A separate connection for the corresponding signal will have to be made (see figure).

In order to reduce the number of switching processes for high-efficiency pumps, the controller is equipped with a relay overrun function that automatically comes into effect when the speed control signal is not issued by the relay itself. The corresponding relay will then remain switched on for an hour after the switch-off conditions are fulfilled.

### In- / Outputs / Outputs

Adjustment channel	Description	Adjustment range / selection	Factory setting
R1 ... R13	Relay output selection	-	-
Signal	Signal type	Adapter, 0-10 V, PWM, Standard	Standard
Output	PWM output selection	17,18,19,20	-
Profile	PWM characteristic curve	A,B,C,D,E,F	A
Min speed	Minimum speed	30 ... 100 %	30 %

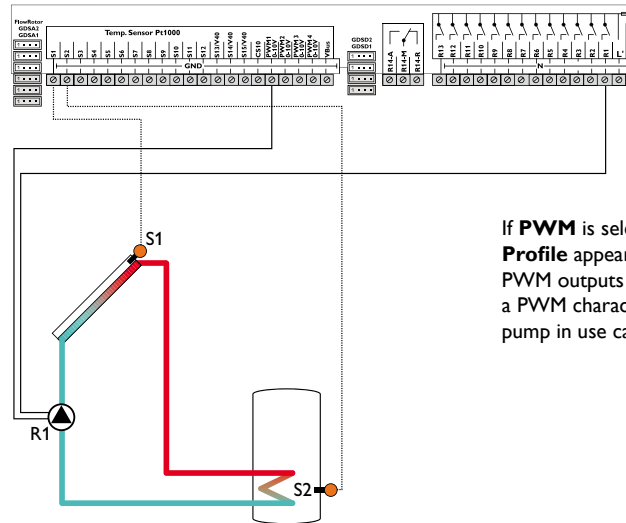

If **PWM** is selected, the channels **Output** and **Profile** appear. In the Output channel, one of the 4 PWM outputs can be selected. In the Profile channel, a PWM characteristic curve corresponding with the pump in use can be selected (see page 75).

Example of the electrical connection of a high-efficiency pump

## 16.4 PWM-Profiles

### PWM A (e. g. manufacturer WILO)

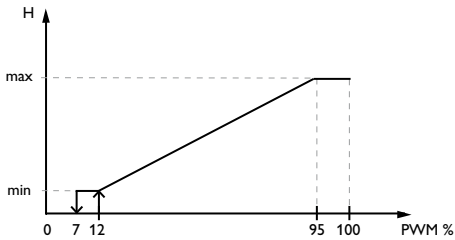

### PWM D (e. g. manufacturer WILO)

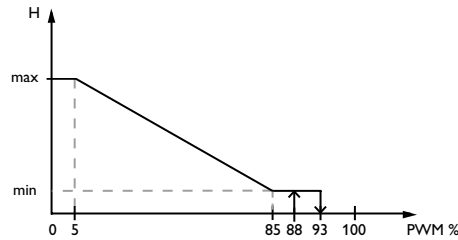

### PWM B (e. g. manufacturer Grundfos)

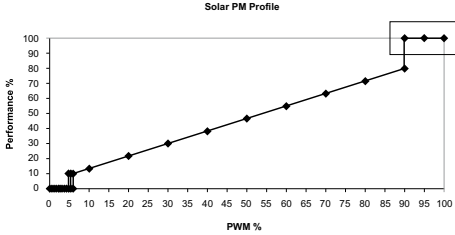

### PWM E (e. g. manufacturer Grundfos)

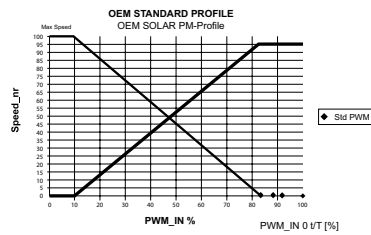

### PWM C (e. g. manufacturer Laing)

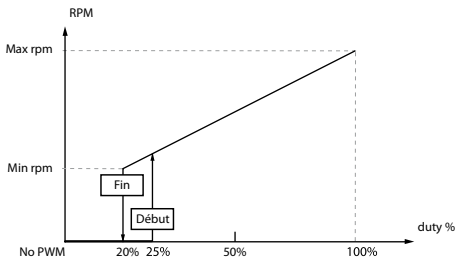

### PWM F (e. g. manufacturer Laing)

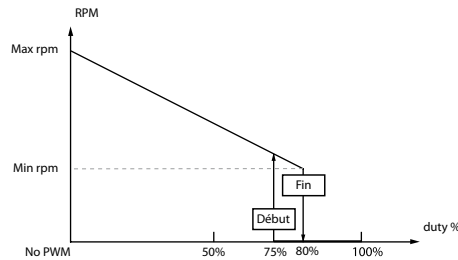

**Note:**



If PWM pumps are used, the lowest adjustment value of the minimum speed cannot be lower than 20 %. If a Laing pump (PWM C) is used, the PWM start impulse has to be higher than 25% to enable a minimum pump speed of less than 25%.

## 17 Troubleshooting

If a malfunction occurs, a message will appear on the display of the controller.



fuse

Directional pad flashes red.

Sensor fault. The error code **!Sensor fault** is displayed instead of a temperature on the sensor display channel.

Short circuit or line break  
Disconnected temperature sensors can be checked with an ohmmeter. Please check the resistance values corresponding with the table.

°C	°F	Ω Pt500	Ω Pt1000	Ω KTY	°C	°F	Ω Pt500	Ω Pt1000	Ω KTY
-10	14	481	961	1499	55	131	607	1213	2502
-5	23	490	980	1565	60	140	616	1232	2592
0	32	500	1000	1633	65	149	626	1252	2684
5	41	510	1019	1702	70	158	636	1271	2778
10	50	520	1039	1774	75	167	645	1290	2874
15	59	529	1058	1847	80	176	655	1309	2971
20	68	539	1078	1922	85	185	664	1328	3071
25	77	549	1097	2000	90	194	634	1347	3172
30	86	559	1117	2079	95	203	683	1366	3275
35	95	568	1136	2159	100	212	693	1385	3380
40	104	578	1155	2242	105	221	702	1404	3484
45	113	588	1175	2327	110	230	712	1423	3590
50	122	597	1194	2413	115	239	721	1442	3695

### WARNING! Electric shock!



Upon opening the housing, live parts are exposed.

→ **Always disconnect the controller from power supply before opening the housing!**

The controller is protected by a fuse. The fuse holder (which also holds the spare fuse) becomes accessible when the cover is removed. To replace the fuse, pull the fuse holder from the bottom.

The display is permanently off.

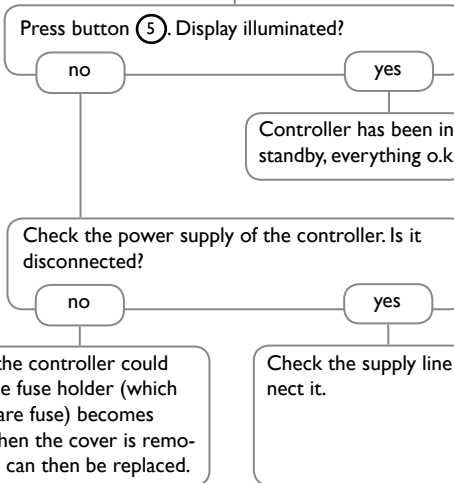

Pump is overheated, but no heat transfer from the collector to the store, flow and return have the same temperature; perhaps also bubbling in the lines.

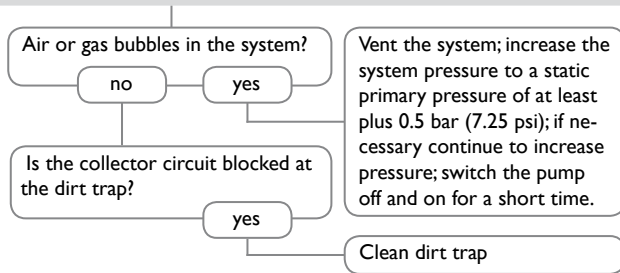

Pump starts for a short moment, switches off, switches on again, etc.

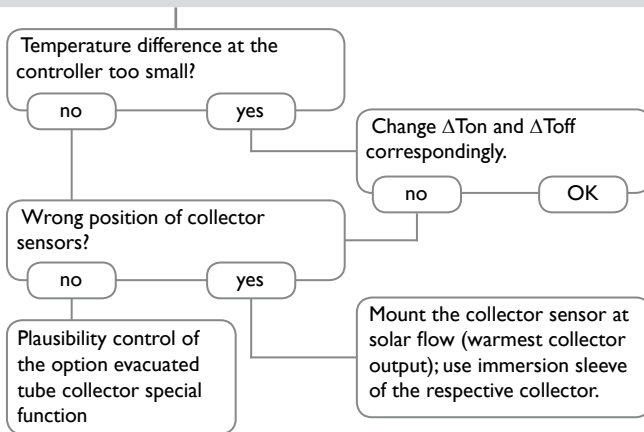

Pump starts up very late.

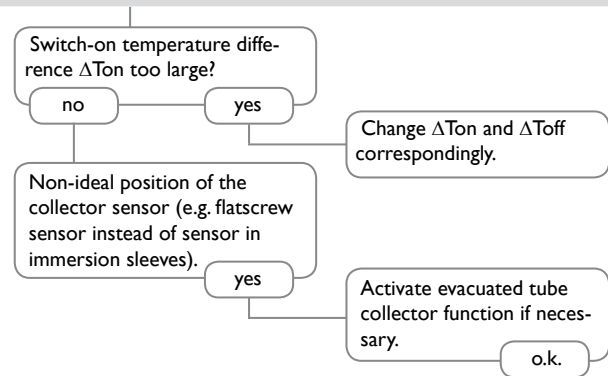

The temperature difference between store and collector increases enormously during operation; the collector circuit cannot dissipate the heat.

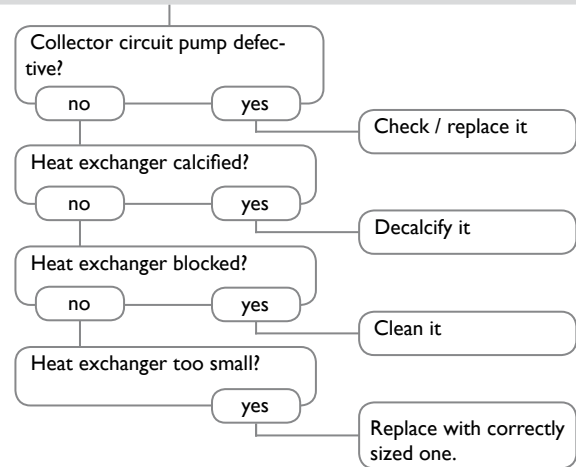

The solar circuit pump does not work, although the collector is considerably warmer than the store.

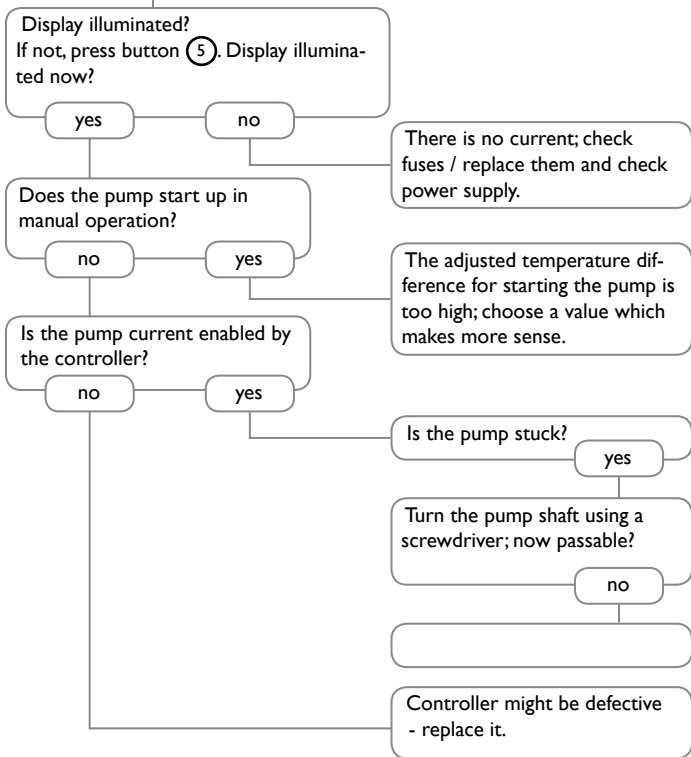

Stores cool down at night.

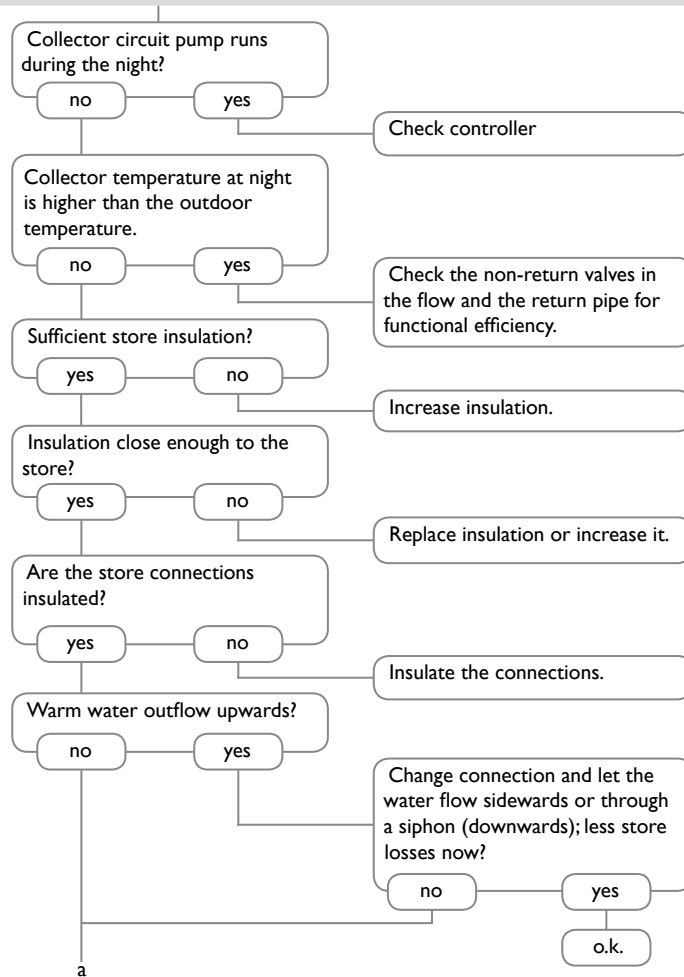

a

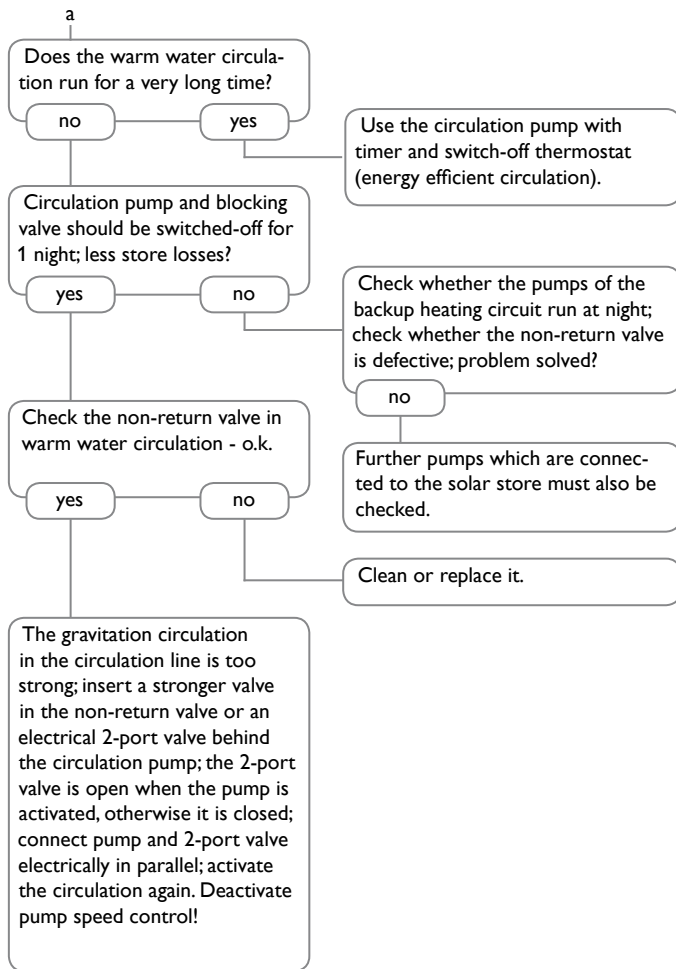

## 18 Accessories

### 18.1 Sensors and measuring instruments



#### Temperature sensors

The product range includes high-precision platinum temperature sensors, flatscrew sensors, outdoor temperature sensors, indoor temperature sensors, cylindrical clip-on sensors, also as complete sensors with immersion sleeve.



#### Overvoltage protection device

In order to avoid overvoltage damage at collector sensors (e.g. caused by local lightning storms), we recommend the overvoltage protection SP10.

**SP10**

Article no.: **180 110 70**



#### AM1 Alarm module

The AM1 Alarm module is designed to signal system failures. It is to be connected to the VBus® of the controller and issues an optical signal via the red LED if a failure has occurred. The AM1 also has a dry contact relay output, which can e. g. be connected to a building management system (BMS). Thus, a collective error message can be issued in the case of a system failure. Depending on the controller and the sensors connected, different fault conditions can be signaled, e. g. sensor failures, excess or negative system pressure as well as errors in the flow rate, such as a dry run of the pump.

The AM1 Alarm module ensures that occurring failures can be immediately recognised and repaired, even if the system and the controller are difficult to access or located in a remote place. Thus, the reliability and the stable yield of the system are ensured.

**AM1**

Article no.: **180 008 70**



#### VFS and RPS Grundfos Direct Sensors™

The RPS Grundfos Direct Sensor™ is a sensor for measuring the temperature and the pressure.

The VFS Grundfos Direct Sensor™ is a sensor for measuring the temperature and the flow rate.

**RPS 0-10 bar**

Article no.: **130 000 47**

**VFS 1-12 analog**

Article no.: **130 000 27**

**VFS 2-40 analog**

Article no.: **130 000 37**



#### V40 flowmeter

The V40 is a measuring instrument for detecting the flow of water or water/glycol mixtures. After a specific volume has passed, the V40 reed switch sends an impulse to the calorimeter. The heat quantity used is calculated by the calorimeter using these impulses and the measured temperature difference with the help of pre-defined parameters (glycol type, concentration, heat capacity, etc.).

**V40**

Article no.: **280 011 00**



## 18.2 VBus® accessories



### Smart Display SD3 / Large Display GA3

The Smart Display is designed for simple connection to controllers with VBus®. It is used for visualizing data issued by the controller: collector temperature, store temperature and energy yield of the solar thermal system. The use of high-efficiency LEDs and filter glass assures a high optical brilliance and good readability even in poor visibility conditions and from a larger distance. An additional power supply is not required. One module is required per controller.

The GA3 is a completely mounted large display module for visualization of collector- and store temperatures as well as the heat quantity yield of the solar system via one 6-digit and two 4-digit 7-segment-displays. An easy connection to all controllers with VBus® is possible. The front plate is made of antireflective filterglass and is printed with a light-resistant UV-lacquering. The universal VBus® allows the parallel connection of 8 large displays as well as additional VBus® modules.

<b>SD3 °F</b>	Article no.: <b>180 007 77</b>
<b>SD3 °C</b>	Article no.: <b>180 004 90</b>
<b>GA3 °F</b>	Article no.: <b>180 007 87</b>
<b>GA3 °C</b>	Article no.: <b>180 006 50</b>



### DL2 Datalogger

This additional module enables the acquisition and storage of large amounts of data (such as measuring and balance values of the solar system) over a long period of time. The DL2 can be configured and read-out with a standard internet browser via its integrated web interface. For transmission of the data stored in the internal memory of the DL2 to a PC, an SD card can be used. The DL2 is appropriate for all controllers with VBus®. It can be connected directly to a PC or router for remote access and thus enables comfortable system monitoring for yield monitoring or for diagnostics of faults.

### DL2

Article no.: **180 007 10**

## 18.3 Interface adapters



### VBus® / USB & VBus® / LAN interface adapters

The new VBus® / USB interface adapter is the interface between the controller and a personal computer. With its standard mini-USB port it enables a fast transmission of system data for processing, visualizing and archiving as well as the parameterization of the controller via the VBus®. A full version of the Service-Center software is included.

The VBus® / LAN interface adapter is designed for the direct connection of the controller to a PC or router. It enables easy access to the controller via the local network of the owner. Thus, controller access, system parameterization and data charting can be effected from every workstation of the network. The VBus® / LAN interface adapter is suitable for all controllers equipped with a VBus®. A full version of the Service-Center software is included.

<b>VBus® / USB</b>	Article no.: <b>180 008 50</b>
<b>VBus® / LAN</b>	Article no.: <b>180 008 80</b>

**A**

Antifreeze, solar optional function..... 39

**B**

Balance values..... 31

Bypass, solar optional function..... 35

**C**

Chimney sweeper function..... 63

Circulation..... 54

Collector cooling, cooling mode..... 41

Collector emergency temperature..... 32

Commissioning menu..... 12

Controller adjustment, loading of..... 70

Controller adjustments, storing of..... 70

Cooling mode..... 41

CS-bypass..... 37

CS-offset..... 73

**D**

Data logging..... 70

Day/Night operation, heating circuit..... 60

DHW heating..... 66

Drainback option..... 44

ΔT function..... 57

**E**

Error messages..... 30

Error messages, acknowledgement of..... 30

External heat exchanger, solar optional function... 43

**F**

Flow rate monitoring..... 46

Flow r. monit., error message..... 30

Formatting the SD card..... 70

Function block..... 57

Fuse, replacing of..... 76

**H**

Heat dump..... 46

Heat exchange..... 52

Heating circuits, internal..... 60

Heating demands..... 60

Heating period thermal disinfection..... 65

Heat quantity measurement..... 67

**I**

Irradiation switch..... 59

**M**

Mains connection..... 7

Manual mode..... 71

Meas. values..... 31

Message relay..... 51

Minimum collector limitation..... 32

Mixer, optional arrangement function..... 49

Modules, registration of..... 72

**O**

Operating hours counter..... 31

Operating mode, relays..... 71

**P**

Parallel relay, optional arrangement function..... 48

Parallel relay, solar optional function..... 40

Priority logic..... 33

Progression chart..... 31

PWM pump speed control..... 74

**R**

Registering external modules..... 72

Return preheating..... 56

Room thermostat..... 61

**S**

Sensor fault, error message..... 30

Solar external heat exchanger..... 43

Solid fuel boiler..... 53

Store cooling, cooling mode..... 41

Store loading..... 50

Store sequence control..... 34

Store set temperature..... 33

Summer mode..... 60

System cooling, cooling mode..... 41

**T**

Target temperature, solar optional function..... 39

Technical data:..... 4

Thermostat function..... 57

Tube collector function..... 38

Twin pump..... 45

**U**

User code..... 72



Distributed by:

**Stiebel Eltron, Inc.**

17 West Street | USA - West Hatfield, MA 01088

Phone: (413) 247-3380 | Fax: (413) 247-3369

info@stiebel-eltron-usa.com

www.stiebel-eltron-usa.com

**Important note**

The texts and drawings of this manual are correct to the best of our knowledge. As faults can never be excluded, please note:

Your own calculations and plans, under consideration of the current standards and directions should only be basis for your projects. We do not offer a guarantee for the completeness of the drawings and texts of this manual - they only represent some examples. They can only be used at your own risk. No liability is assumed for incorrect, incomplete or false information and / or the resulting damages.

**Note**

The design and the specifications can be changed without notice.

The illustrations may differ from the original product.

**Imprint**

This mounting- and operation manual including all parts is copyrighted. Another use outside the copyright requires the approval of **Stiebel Eltron, Inc.** This especially applies for copies, translations, micro films and the storage into electronic systems.

**Editor: Stiebel Eltron, Inc.**